

---

Planning and Installation Manual  
**UNITY/I””**  
**UT31 20, UT31 60, UT3220**

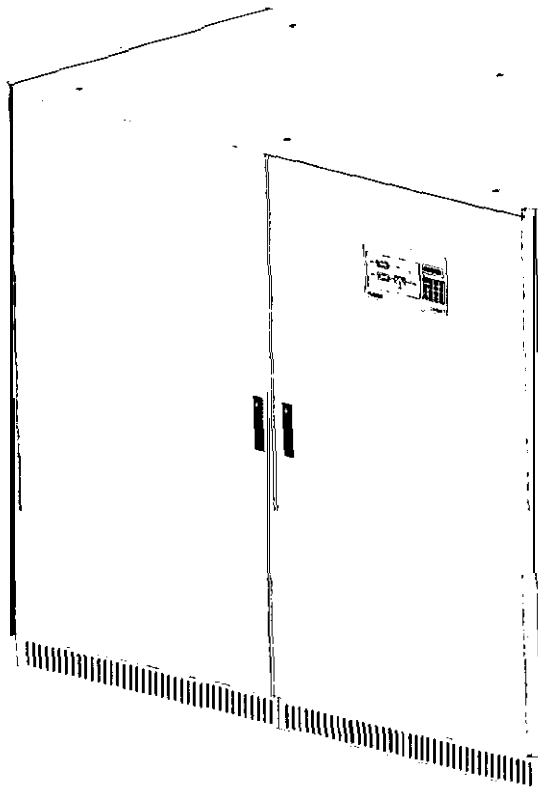

**Three-Phase Uninterruptible Power Systems**  
60 Hz



LTM-0356C  
Copyright 2000, Best Power. All rights reserved.

 **Best  
Power**  
UNINTERRUPTIBLE  
POWER SYSTEMS

## **IMPORTANT SAFETY INSTRUCTIONS SAVE THESE INSTRUCTIONS**

**This manual contains important instructions for your UNITY/P UPS.**

The installation and use of this product must comply with all national, federal, state, municipal, or local codes that apply. If you need help, please call BEST's Technical Support Center at 1-800-356-5737 (U.S.A. or Canada; elsewhere, call your local BEST office).

### **WARNING!**

UPS units contain hazardous AC and DC voltages. A qualified electrician must install the UPS, AC line service, and external batteries. The electrician must install AC line according to local and national codes and must be familiar with batteries and battery installation.

Before installing, maintaining, or servicing the UPS, shut off the UPS and disconnect all **sources** of AC and DC power.

Whenever AC and/or DC voltage is applied, there will be AC voltage at the UPS output; this is true because the UPS can supply output power from mains or from its batteries. To avoid equipment damage or personal injury, always assume that there may be voltage at the UPS output.

### **TEST BEFORE TOUCHING!**

To reduce the risk of fire or electric shock, install the UPS and external batteries in a temperature and humidity controlled indoor area, free of conductive contaminants.

UPS batteries are high current sources. Shorting battery terminals or DC terminal strips can cause severe arcing, equipment damage and injury. A short circuit can cause a battery to explode. Always wear protective clothing and eye protection and use insulated tools when working near batteries.



This unit contains components that are sensitive to electrostatic discharge (ESD). If you do not follow proper ESD procedures, you may cause severe damage to electronic components.

<b>UT3120, UT3160, and UT3220</b> <b>Planning and Installation Manual</b>
--

**Table of Contents**

	L i s t o f T a b l e s a n d F i g u r e s	ii
100:	Introduction .....	1
	101: UPS Footprint .....	. 2
	102: Specifications .....	. 3
	103: Receiving and Moving the UPS .....	. 5
	104: Storing the UPS and Batteries .....	. 6
	105: Finding a Location for the UPS .....	. 6
	106: Conduit Connection Kit Installation Instructions .....	. 7
	107: Technical Support .....	. 8
200:	Installation .....	. 9
	201: Installing the Maintenance Bypass Cabinet (MBC) and UPS .....	. 9
	202: Installing the External Batteries and DC Disconnect (DCD) .....	18
300:	Initial Startup and Phase Check .....	22
400:	Clearing the Events Log .....	25
500:	Shutdown Procedure .....	26
600:	S t a r t u p f r o m M a i n t e n a n c e B y p a s s .....	27
700:	Glossary of Terms and Abbreviations .....	28
	701: Glossary of Terms .....	28
	702: Abbreviations .....	28

<b>UT3120, UT3160, and UT3220 Planning and Installation Manual</b>
--

**List of Tables and Figures**

**Tables**

1	AC Input Specifications .....	. 3
2	AC Output Specifications .....	. 3
3	DC Input/Battery Specifications. ....	. 4
4	General Specifications .....	. 4

**Figures**

1	Footprint of the UT3120, UT3160, UT3220 with Conduit Box (Top View).	. 2
2	Front View of the UT3 120, UT3160, UT3220 (Covers Removed) .	11
3	U P S   W i r i n g   T e r m i n a t i o n s	12
4	UT3 120 - UT3220 Installation Wiring Diagram, Typical Installation without External Maintenance Bypass Cabinet	13
5	UT3 120 - UT3220 Installation Wiring Diagram, Typical Installation with External Maintenance Bypass Cabinet	14
6	External Connection Board	. . . 15
7	Communication      Interface      Board      (Optional) .	16
8	Relay      Board      (Optional) .	. . 17

---

## **Section 100: Introduction**

---

An uninterruptible power system (UPS) protects sensitive equipment against unacceptable disturbances from the mains (AC line) supply. The UNITY/I™ three-phase UPS has the capacity to serve a wide variety of electrical equipment—from mainframe computers to enterprise-wide EDP installations to production lines. The UNITY/I three-phase UPS provides true on-line, single-conversion technology and harmonics isolation.

Only a qualified electrician should install this unit. The planning and installation manual gives the electrician guidelines for:

- a installation wiring.
- external battery installation.
- UPS startup procedures.
- phase check for the maintenance bypass cabinet.
- UPS shutdown procedures.

If you need assistance, please have the UPS model number and serial number available and call BEST's Technical Support Center at 1-800-356-5737 (U.S.A. or Canada) or call your local BEST office.

**UT3120, UT3160, and UT3220  
Planning and Installation Manual**

**101 UPS Footprint**

Figure 1 shows the UPS footprint.

**Figure 1: Footprint of the UT3120, UT3160, UT3220 with Conduit Box (Top View)**

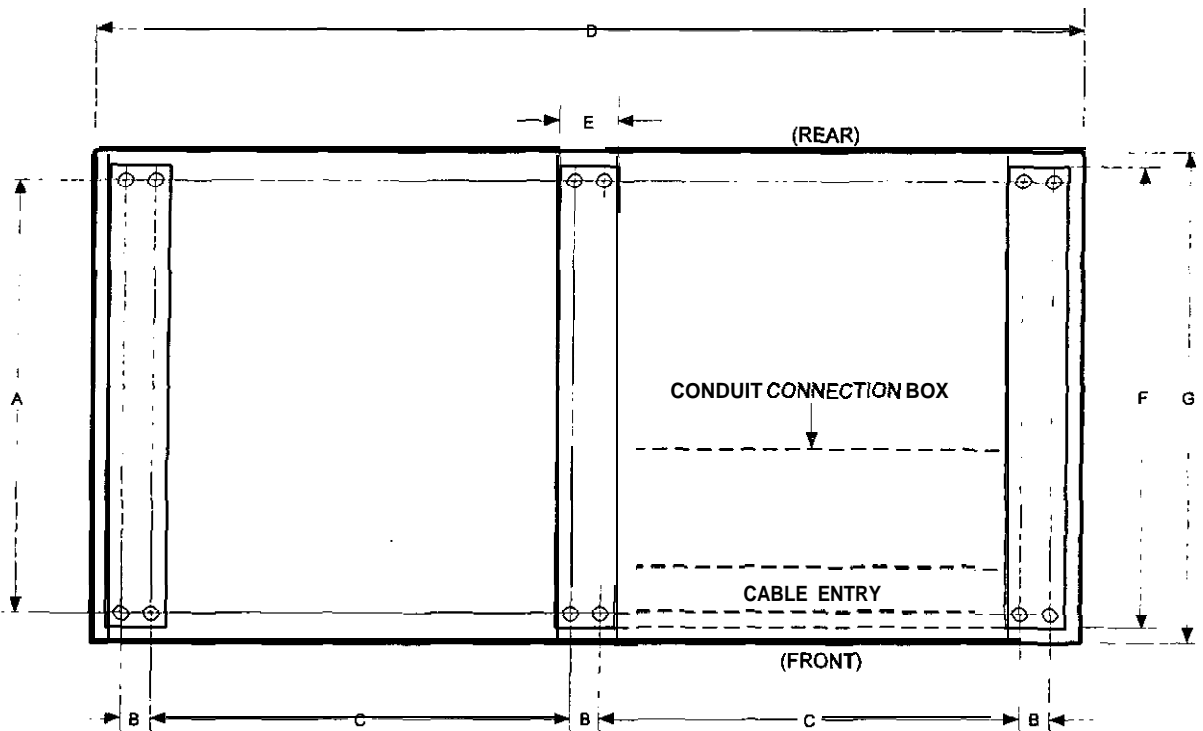

	Inches	Millimeters
<b>A</b>	28.3	720
<b>B</b>	2.0	50
<b>C</b>	26.6	675
<b>D</b>	63.0	1600
<b>E</b>	3.9	100
<b>F</b>	29.5	750
<b>G</b>	31.5	800

For service clearance and air flow, allow a minimum of 3 feet (914 mm) at the front, 3 feet (914 mm) at the top, and 6 inches (150 mm) at the back of the unit.

Cable entry from bottom only.

Conduit connection box shipped separately.

**UT3120, UT3160, and UT3220  
Planning and Installation Manual**

## 102 Specifications

Tables 1 - 5 contain specifications for UPS models UT3120 - UT3220.

**Table 1: AC Input Specifications**

	UT3120	UT3160	UT3220
Voltage	3 x 480Y/277	3 x 480Y/277	3 x 480Y/277
Rated input current - Amps	190	253	348
Mains tolerance % (programmable)	-15, +10	-15, +10	-15, +10
Bypass tolerance % (programmable)	±10	±10	±10
Frequency - Hz	60 ±6%	60 ±6%	60 ±6%
Current distortion % - THD	0 - 5	0 - 5	0 - 5
Recommended overcurrent protection - Amps <sup>1,2</sup>	250	350	450
UPS module AC input wiring terminations <sup>3</sup>	Four bus bars (L1, L2, L3, N). Up to three wires per bus bar. M12 x 30 hardware provided. Lug required.		

**Table 2: AC Output Specifications**

	UT3120	UT3160	UT3220
Voltage	3 x 480Y/277	3 x 480Y/277	3 x 480Y/277
Rated output current - Amps	144	193	265
Tolerance %	- symmetrical load - asymmetrical load <sup>4</sup> - load step 0 - 100%	±1 ±3 ±5	±1 ±3 15
Distortion % - linear load	0 - 3	0 - 3	0 - 3
Frequency - Hz	mains synchronized - free running	60 ±6% 60 ±0.1%	60 ±6% 60 ±0.1%
Overload capacity %, mains operation:			
- 1 minute	250	250	250
- IO minutes	150	150	150
Overload capacity %, battery operation:			
- 1 minute	150	150	150
- IO minutes	125	125	125
Recommended overcurrent protection - Amps <sup>1</sup>	200	250	350
UPS module AC output wiring terminations <sup>3</sup>	Four bus bars (L1, L2, L3, N). Up to three wires per bus bar. M12 x 30 hardware provided. Lug required.		

Notes for Tables 1 and 2: --

1 For units with external bypass, see Figure 5 in Section 201.

2 For UPS module only (UPS input breaker).

3 M12 x 30 hardware is 12 mm (0.47") in diameter. For detail of bus bars, see Figure 3 in Section 201.

4 100% imbalance, provided output current rating is not exceeded.

<b>UT3120, UT3160, and UT3220</b> <b>Planning and Installation Manual</b>
--

**Table 3: DC Input /Battery Specifications**

	UT3120	UT3160	UT3220
Nominal DC current - Amps	320	425	580
Nominal DC voltage	408	408	408
Nominal number of cells	204	204	204
Factory-set float charge voltage <sup>1</sup>	467	467	467
Charger current limit - Amps <sup>2</sup>	30	45	55
Inverter % efficiency	- 100% load	93	94
	- 75% load	93	94
	- 50% load	91	91
	- 25% load	89	90
UPS module DC wiring terminations <sup>3</sup>	Two bus bars (+, -). Up to three wires per bus bar. MI2 x 30 hardware provided. Lug required.		

Notes for Table 3:

<sup>1</sup> Adjust the float charge voltage setting per the battery manufacturer's recommendations.

<sup>2</sup> Programmable to lower level.

<sup>3</sup> MI2 x 30 hardware is 12 mm (0.47") in diameter. For detail of bus bars, see Figure 3 in Section 201.

**Table 4: General Specifications**

	UT3120	UT3160	UT3220
Noise attenuation - dB	- differential mode	60 - 80	60 - 80
	- common mode <sup>1</sup>	40 - 80	40 - 80
Typical heat dissipation - kW (BTU)	- At full rated load, normal operation	5.00 (17065)	6.67 (22753)
	- At full rated load, economy mode	3.71 (12667)	4.95 (16889)
	- At 0.8 PF load, normal operation	4.00 (13652)	5.33 (18203)
	- At 0.8 PF load, economy mode	2.97 (10133)	3.96 (13511)
Efficiency %, AC to AC	- normal operation	96	96
	- economy mode		
Humidity %, non-condensing max.	95	95	95
Ambient UPS/battery temp. - °F (°C)	32 - 104 (0 - 40)	32 - 104 (0 - 40)	32 - 104 (0 - 40)
Ideal UPS/battery temp. - °F (°C)	77 (25)	77 (25)	77 (25)
Air flow - CFM (m <sup>3</sup> /hr)	1767 (3000)	1767 (3000)	1767 (3000)
Audible noise, typical - dBA	73	73	73
UPS dimensions, with conduit connection kit, HxWxD - inches (mm)	75 x 63 x 31.5 1905 x 1600 x 800)	75 x 63 x 31.5 (1905 x 1600 x 800)	75x63x31.5 (1905 x 1600x800)
UPS weight, with conduit connection kit - lbs (kg)	3729 (1691)	4831 (2191)	5493 (2492)
Floor loading, UPS with conduit connection kit - lbs per sq. inch (kPa)	10.69 (73.72)	13.85 (95.51)	15.75 (108.60)

Notes for Table 4:

<sup>1</sup> 120 dB with optional isolation transformer.



---

**103 Receiving and Moving the UPS**

---

 **WARNING!**

The UPS and related equipment are very heavy. To prevent personal injury or equipment damage, use extreme care when handling and transporting the UPS cabinet and related equipment.

1. While the UPS system is still on the truck, inspect the equipment and shipping container(s) for any signs of damage. Do not install the system if damage is apparent. If damage has occurred, notify BEST as soon as possible.
2. Compare the shipment with the bill of lading. Report any missing items to the carrier and to BEST immediately.
3. Remove the screws on the bottom part of the packaging side plates.
4. Lift the main package up and off the unit and remove the packing materials from the unit
5. Check that the label inside the UPS front door corresponds to the system ordered, especially the input/output voltages.
6. Unbolt the unit from the pallet.
7. Remove the unit from the pallet with a fork lift,
8. Use a fork lift or hand truck to transport the unit to the installation site or storage site. Study the footprint to decide how you will move the UPS through doorways and into position.
9. Install the separately shipped conduit connection kit. See the conduit connection kit for installation instructions, Section 106 contains a summary of these instructions for your review.

---

## **104 Storing the UPS and Batteries**

---

You can store the **UNITY/I** UPS between -4° and 104° F (-20° and 40° C). However, BEST recommends that the unit and batteries be stored between 59° and 77° F (15° and 25° C). This temperature range, or cooler, allows batteries to have a longer shelf life. Recharge stored batteries every **90 to 120** days.

---

## **105 Finding a Location for the UPS**

---

Keep these guidelines in mind when you choose the location for the UPS system and the batteries.

- Place the UPS in a clean, dust-free environment, free of contaminants. The air must be free to circulate around the UPS cabinet and any battery cabinets or racks.
- Avoid placing the unit in direct sunlight or near other heat sources.
- Make sure that the ambient temperature is 32° to 104° F (0° to 40° C). Ideal temperature is 77° F (25° C).

**NOTE:** At 92° F (33° C), battery life will be about one-half what it would be at a normal temperature of 77° F (25° C). At 113° F (45° C), battery life will be about **one-fourth** normal.

- ⌚ Make sure that the floor can support the weight of the UPS, external batteries, and any other necessary equipment. See Table 4 for weights and floor loading specifications.
- ⌚ The unit can be placed close to walls as long as there is enough clearance for the front doors to open. Required service clearance is 3 feet (1 meter) at the front and 3 feet (1 meter) at the top of the unit. If possible, allow a minimum of 3 feet (1 meter) of clearance around the entire unit for easier servicing.
- All service access is from the front and top of the unit. All cable entries are accessible from the bottom of the unit.
- Do not operate the UPS or batteries in a sealed room or container.

---

## 106 **Conduit Connection Kit Installation Instructions**

---

This procedure describes how to install the conduit connection kit for models UT340, UT360, UT380, and UT3 100. To install the pedestals, you must provide equipment capable of safely elevating the UPS several inches above the floor. **Tools required:** 13 mm ratchet or wrench; T20 torx screwdriver; Greenley punch.

### **Kit Contents:**

<u>For pedestals</u>	<u>For conduit box</u>	<u>For base covers</u>
(3) pedestals	(1) conduit box	(2) side base covers
(4) bolts, MS x 100 mm	(1) conduit box cover	(2) front/rear base covers
(4) lock washers, M8	(11) T20 torx screws, M5 x 12mm	Hook and loop fasteners
(4) flat washers, MS	(11) lock washers, M5	
(4) nuts, MS	(11) flat washers, M5	

### **Installing the Pedestals:**

1. Remove the brackets connected to the legs of the UPS during shipping.
2. Use a lifting device to lift the UPS off the floor. Place the pedestals under the UPS legs so that the holes on the pedestals will align with the holes on the UPS legs.

**NOTE:** There are holes on *three sides* of each leg. Place the pedestals so that the holes on all sides of the legs are aligned properly.

3. Slowly lower the UPS legs into the pedestals.
4. On the four corner legs of the UPS, insert bolts, with washers and nuts (**do not tighten**).

**NOTE:** Place the flat washer under the bolt head and the lock washer under the nut.

5. Set the unit in its desired location.
6. Tighten all of the bolts.

### **Installing the Conduit Box and Base Covers**

1. Punch conduit holes in the back of the conduit box
2. Place the conduit box between the center leg and right leg of the unit, with the open side facing the front of the unit.

**UT3120, UT3160, and UT3220  
Planning and Installation Manual**

3. Use four T20 **torx** screws and washers to fasten the conduit box to the front legs of the UPS.

**NOTE:** Attach hardware in this order: flat washer, lock washer, screw.

4. After all of the wiring to the unit is complete, attach the conduit box cover to the front of the conduit box.
5. Use the hook and loop fasteners to attach the base covers to the UPS.

---

## **107      Technical Support**

---

Best Power is committed to outstanding customer service. Our Technical Support Center is happy to help you with any problems or answer any questions you may have. A service technician is available 24 hours a day, 365 days a year.

Please have the **UPS model number and serial number** available when you call. See the ID label located inside the front door of the UPS.

Technical Support:            1-800-356-5737 (U.S.A. and Canada) or 1-608-565-2100

Technical Support Fax:        1-608-565-2509

Service Fax on Demand:      1-608-565-9499 ext. 9000

World Wide Web Site:        <http://www.bestpower.com>

---

## Section 200: Installation

---

### **WARNING!**

Before continuing, read the warnings on the inside front cover of this manual.

#### Insulated Tools and Other Equipment Needed:

- Torque wrench in inch-pounds or newton-meters
- Standard U.S. and metric wrenches
- Petroleum jelly or conductive grease
- Mallet
- Volt-Ohm meter (True RMS - Digital)
- Pliers
- Ratchet and Sockets
- Electrical Tape
- Standard and Phillips Screwdrivers
- Torx Head Screwdriver Set
- Brush (for applying petroleum jelly or conductive grease to battery terminals)
- *UNITY/I User Manual*
- Phase Rotation Meter

The customer must provide all cabling and interconnection hardware.

---

## 201 Installing the Maintenance Bypass Cabinet (MBC) and UPS

---

### **IMPORTANT!**

If you do not have a BEST maintenance bypass cabinet (MBC), you must provide overcurrent protection and a UPS input AC disconnect means.

BEST **strongly recommends** that a means of bypassing the UPS from the critical load be provided for maintenance.

Follow these guidelines when installing the MBC and UPS:

- Use the information in Section 105 to find an appropriate location for the UPS. Install the conduit connection kit per the instructions provided with the conduit connection kit.
- Install the MBC within sight of the UPS. When installing the MBC, see Figure 5 and any instructions provided with the MBC.

<p style="text-align: center;"><b>UT3120, UT3160, and UT3220</b> <b>Planning and Installation Manual</b></p>
--

- Install all wiring in accordance with national and local electrical codes. Use 75°C copper conductors.
- Install the AC input and UPS output in separate conduits. **UPS output cabling shall be installed in dedicated conduit systems** and not shared with other electrical circuits.
- Control wiring must be installed in separate conduit,
- Good ground connections are necessary to reduce electrical noise and make the operation of the UPS and the loads safe. Follow the grounding guidelines in the installation wiring diagram. Refer to the National Electrical Code (NEC), appropriate IEEE documents, and all applicable codes.
- For systems with non-linear loads, recommended practice is to size the neutral conductor for 1.732 times the phase current.
- When installing the AC wiring, refer to Figure 4 or 5 and to any additional diagrams provided with **the** UPS. Figures 4 and 5 show **typical installations**. Your installation may differ.
- See Figure 2 for a front view of the UPS with the covers removed. See Figure 3 for a view of the UPS module wiring terminations. See Figure 6 for information on the external connection board. See Figure 7 for information on the optional communication interface board. See Figure 8 for information on the optional relay board.

**UT3120, UT3160, and UT3220  
Planning and Installation Manual**

**Figure 2: Front View of UT3120, UT3160, UT3220 (Covers Removed)**

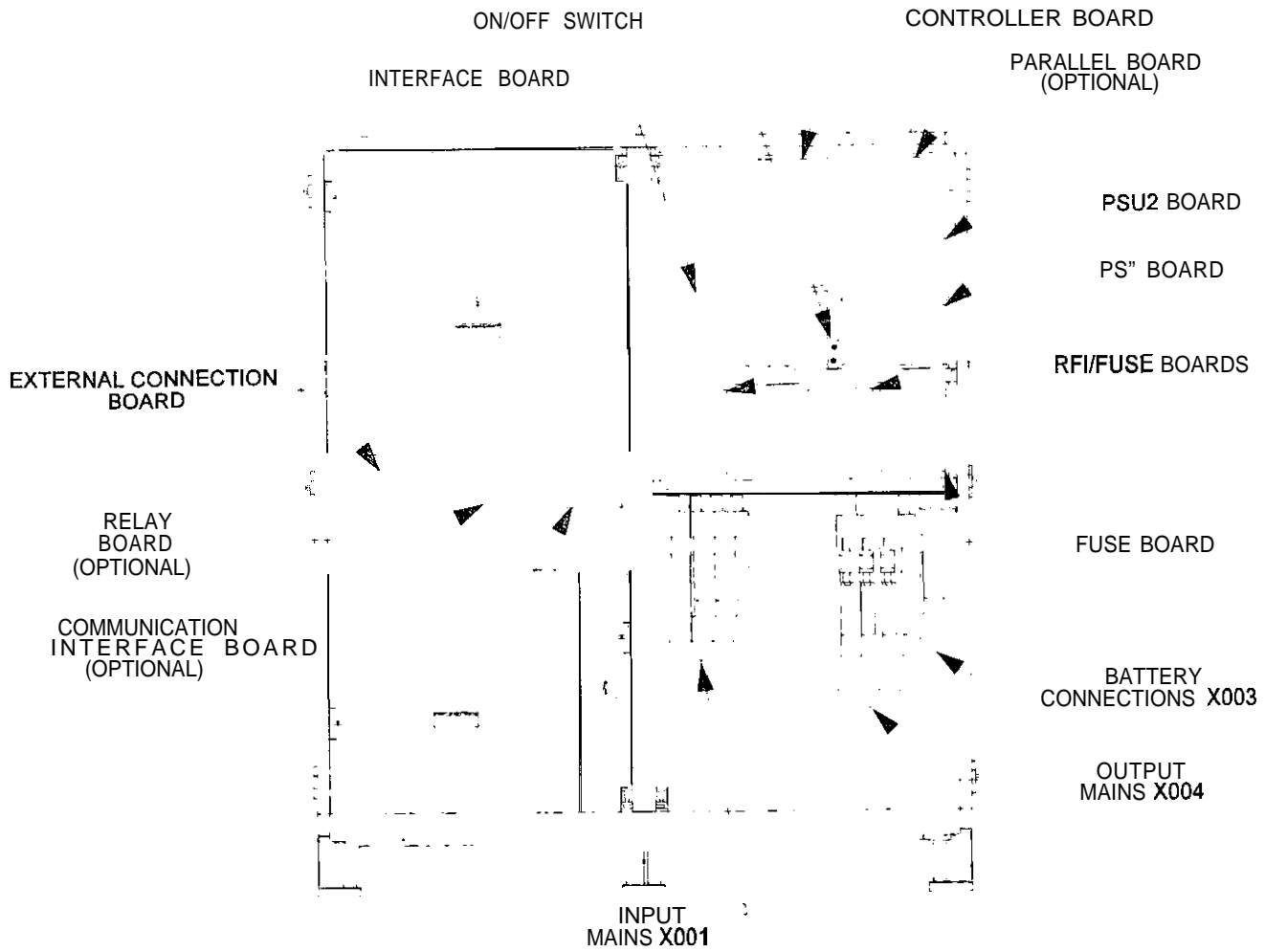

**UT3120, UT3160, and UT3220  
Planning and Installation Manual**

**Figure 3: UPS Wiring Terminations**

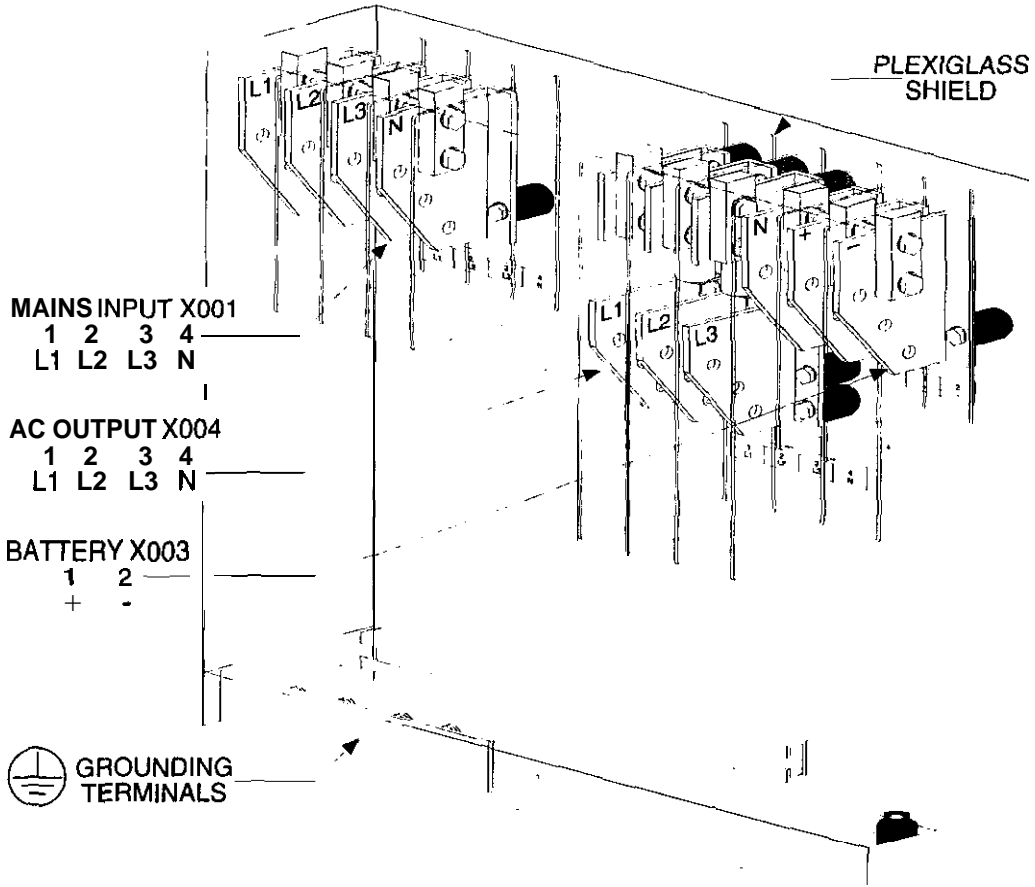

**INPUT AND DC**

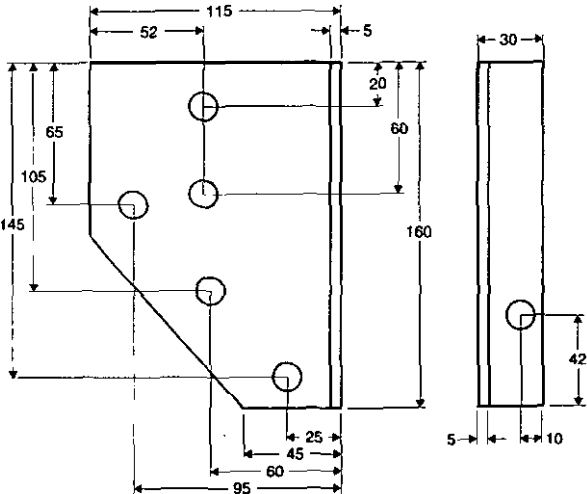

**OUTPUT L1, L2, L3**

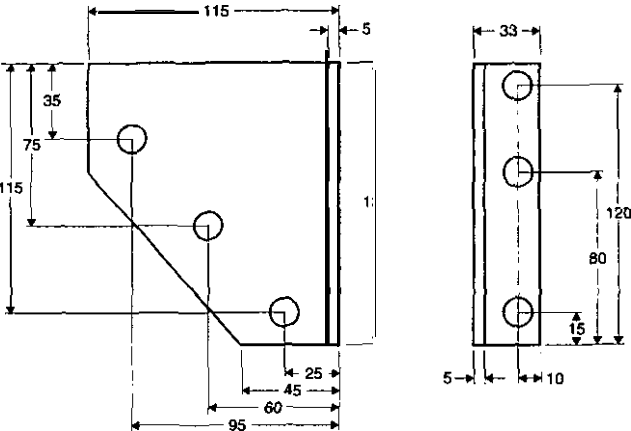

NOTES: All dimensions are in millimeters.  
All holes are 13 mm (0.51") in diameter.  
M12 x 30 hardware is provided.



# UT3120, UT3160, and UT3220 Planning and Installation Manual

**Figure 4: UT3120 - UT3220 Installation Wiring Diagram, Typical Installation Without External Maintenance Bypass Cabinet**

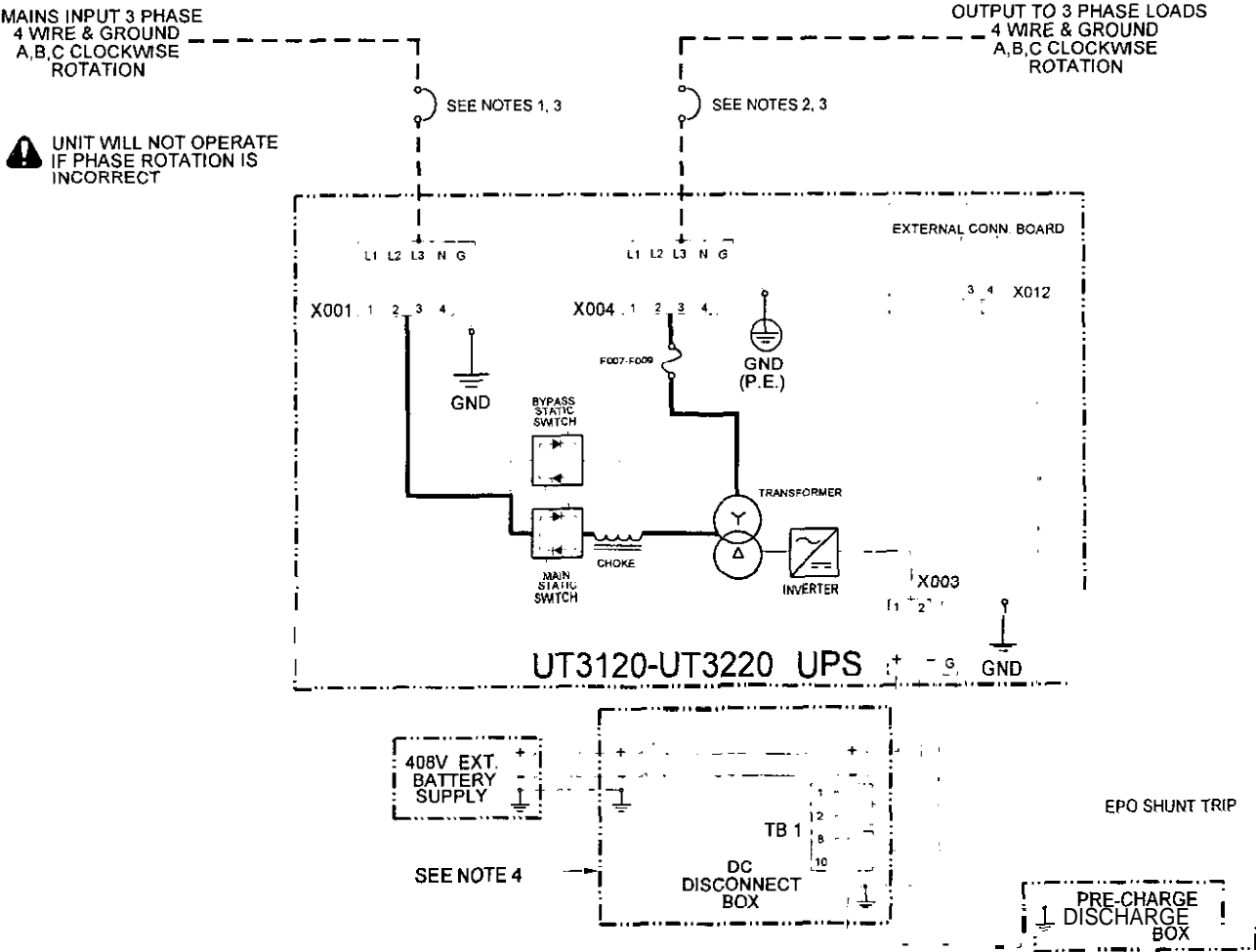

NOTE 1: See Table 1 in Section 102 for recommended input **overcurrent** protection.

NOTE 2: See Table 2 in Section 102 for recommended output **overcurrent** protection.

NOTE 3: The customer must provide **overcurrent** protection and UPS input AC disconnect means.

NOTE 4: (a) Refer to any instructions provided with the DC disconnect (DCD) and pre-charge/discharge box.  
 (b) The pre-charge/discharge box must be located less than 10 feet (3048 mm) from the DC disconnect.  
 (c) DCD and **precharge** may be internal or external to the Battery System Cabinet, dependent on the system ordered.

ADDITIONAL NOTES:  
 • A qualified electrician must install the UPS according to all applicable codes.  
 . Power and control wires must be in separate conduits.

# UT3120, UT3160, and UT3220 Planning and Installation Manual

**Figure 5: UT3120 - UT3220 Installation Wiring Diagram, Typical Installation With External Maintenance Bypass Cabinet**

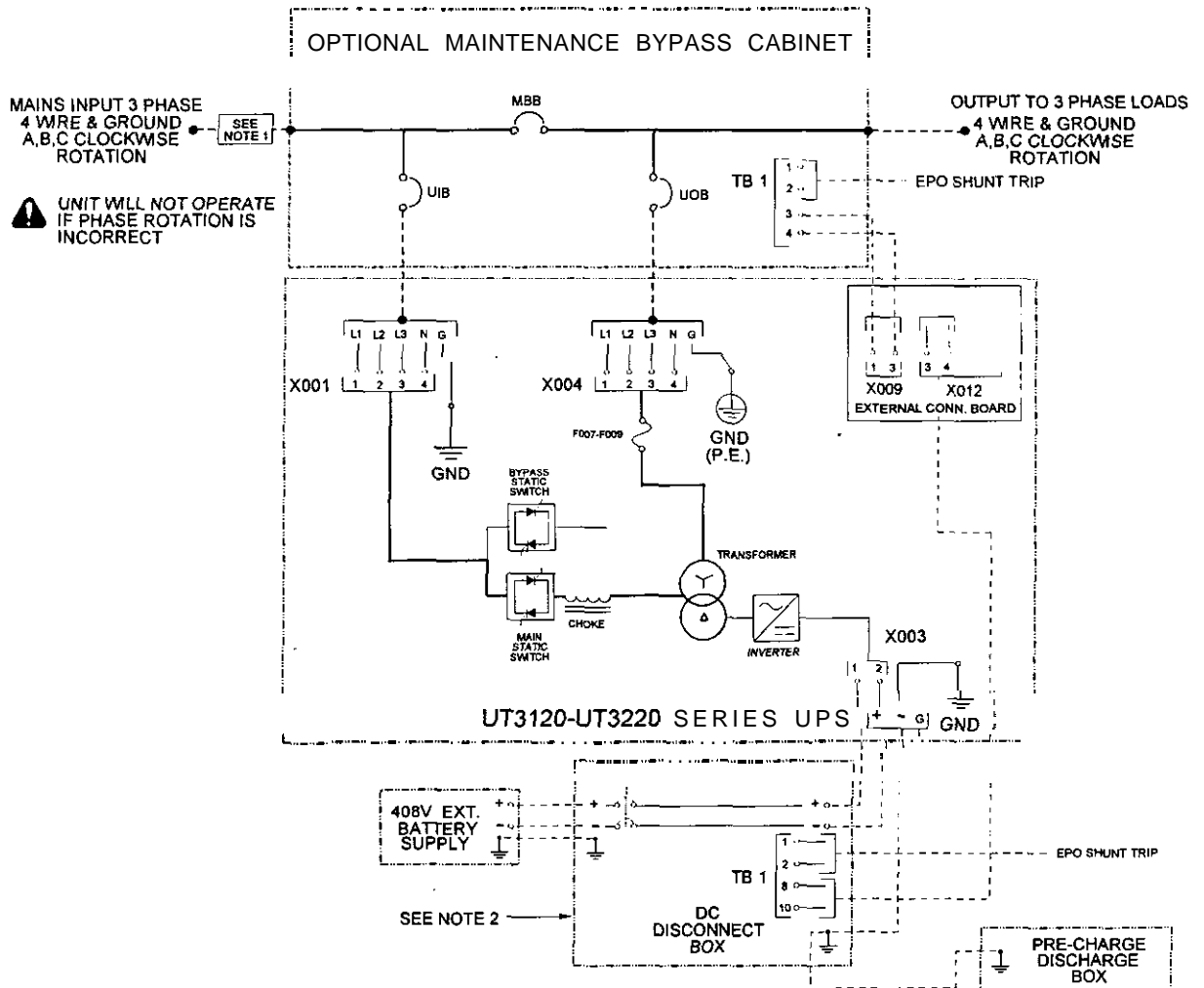

NOTE 1: Size the mains input **overcurrent** protection device per applicable codes. See the table below for **mains input** voltage and current ratings.

UPS Model	Mains Input	
	VAC	Maximum Amps
UT3120	480	260
UT3160	480	347
UT3220	480	477

NOTE 2: (a) Refer to **any** instructions **provided** with the DC disconnect (DCD) and **pre-charge/discharge** box.  
 (b) The **pre-charge/discharge** box must be located less than 10 feet (3048 mm) from the DC disconnect.  
 (c) DCD and **precharge** may be internal or external to the **Battery System Cabinet**, dependent on the system ordered.

**ADDITIONAL NOTES:**

- A qualified electrician must install the UPS according to all applicable codes.
- Power and control wires must be in separate conduits.
- If you do not have a BEST-supplied maintenance bypass cabinet (MBC), you must provide **overcurrent** protection and UPS input AC disconnect means.

**UT3120, UT3160, and UT3220  
Planning and Installation Manual**

**Figure 6: External Connection Board**

Use Class 1 wiring methods.

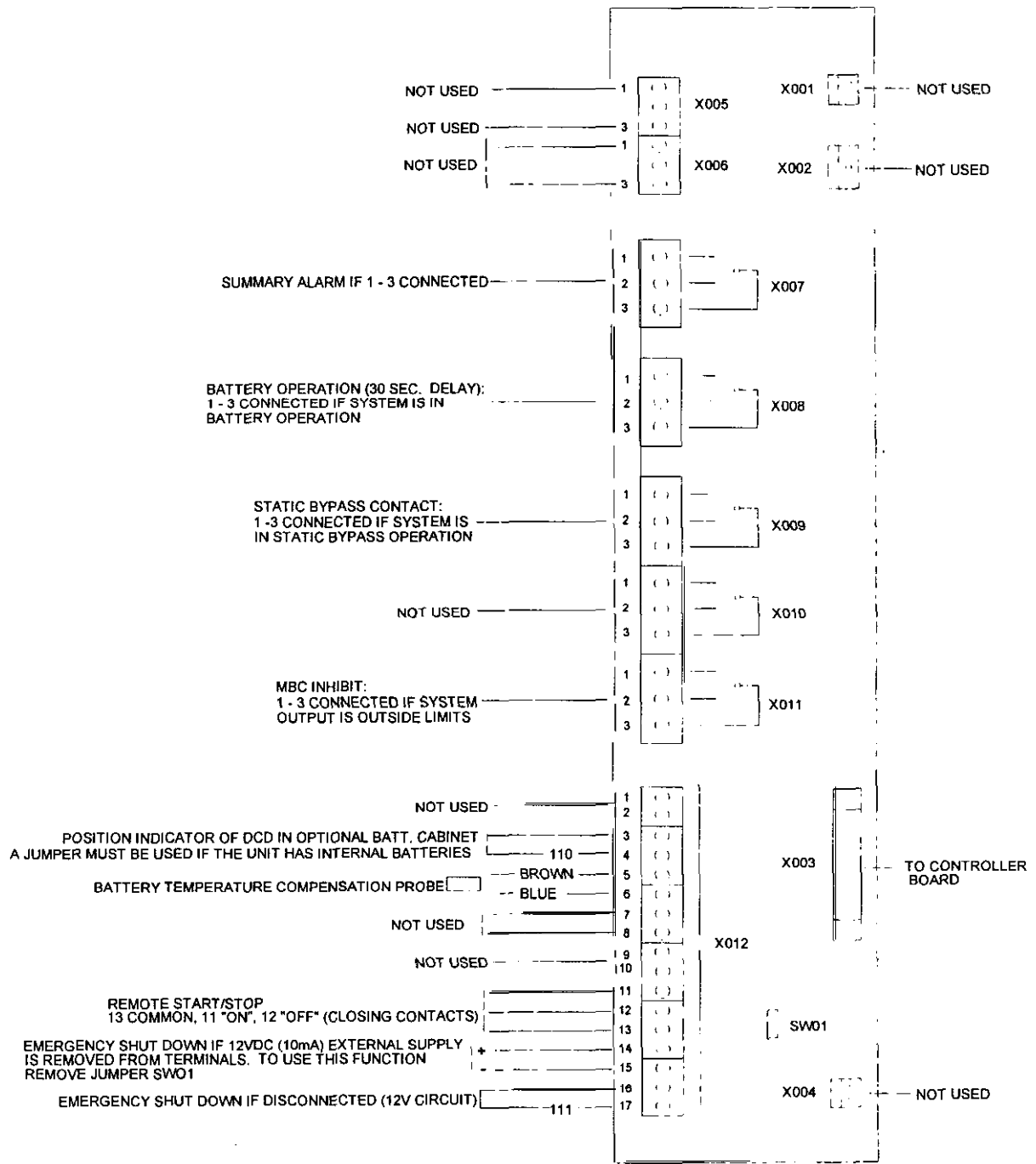

X007-X011 ARE CHANGE OVER RELAY CONTACTS  
(NOT TO EXCEED NEC ARTICLE 725 C CLASS 2 LIMITS: 250 VAC @ 8 A; 60 VDC @ 0.5 A)

**UT3120, UT3160, and UT3220  
Planning and Installation Manual**

**Figure 7: Communication Interface Board (Option)**

Use Class 1 wiring methods.

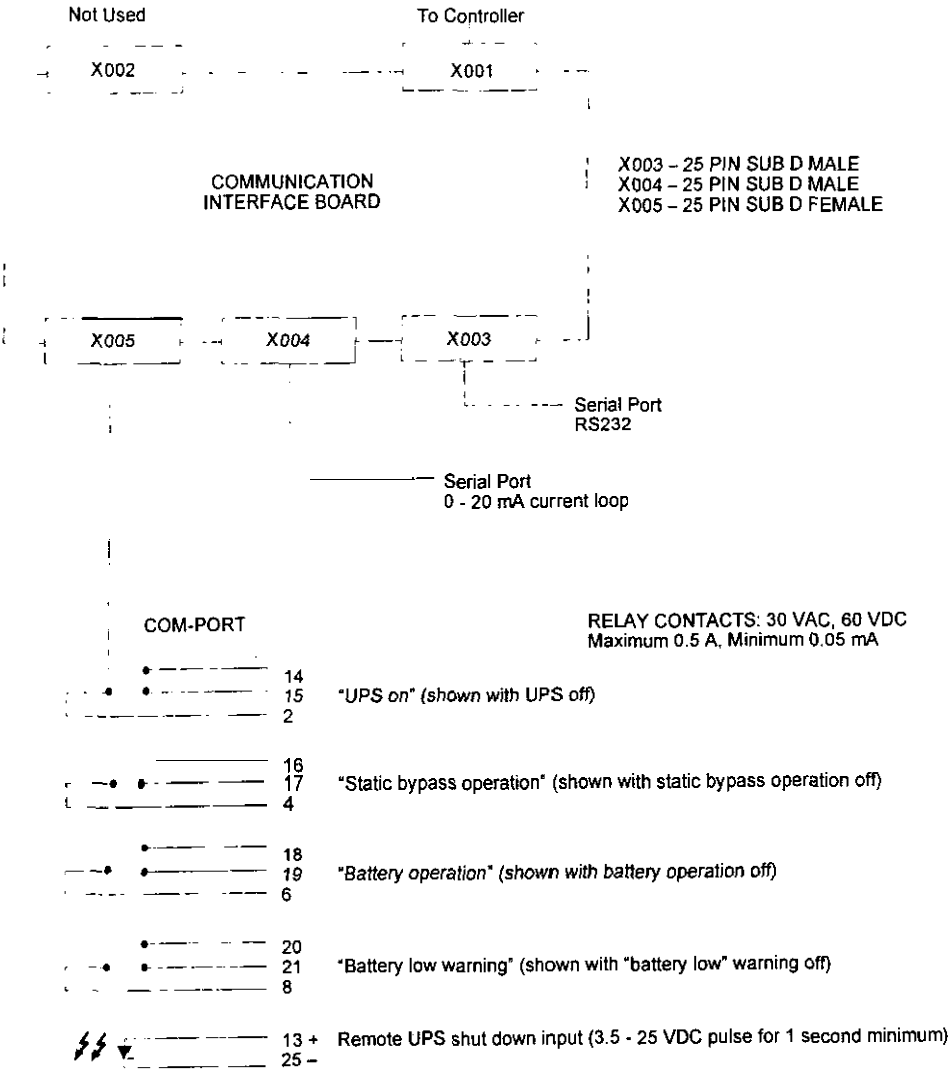

**UT3120, UT3160, and UT3220  
Planning and Installation Manual**

**Figure 8: Relay Board (Option)**

The relays are shown in the alarm position and correspond to non-energized coils.

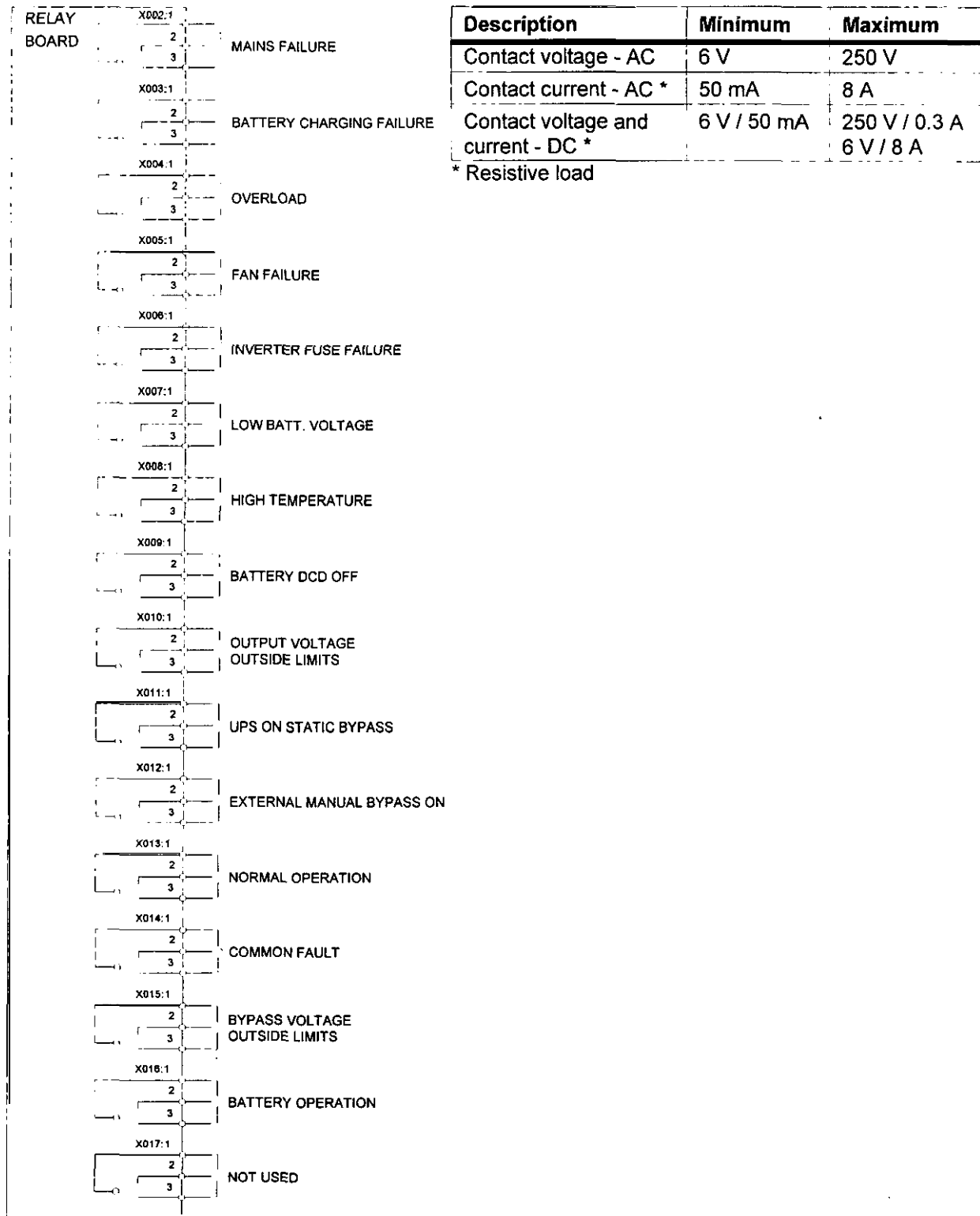

---

## **202    Installing the External Batteries and DC Disconnect @CD)**

---

External batteries must be installed and connected to the UPS by a qualified service person who is familiar with UPS battery installations and applicable building and electrical codes. The qualified service person should read this entire section before the UPS and batteries arrive.



### **DANGER!**

Full voltage and current are always present at the battery terminals. The batteries used in this system can produce dangerous voltages, extremely high currents, and a risk of electric shock. They may cause severe injury if the terminals are shorted together or to ground (earth). You must be extremely careful to avoid electric shock and burns caused by contacting battery terminals or shorting terminals during battery installation. Do not touch uninsulated battery terminals.

A qualified service person who is familiar with battery systems and required precautions must install and service the batteries. The installation must conform to national and local codes. Keep unauthorized personnel away from batteries.

The qualified service person must take these precautions:

1. Wear protective clothing, such as rubber gloves and boots and protective eye wear. Batteries contain caustic acids and toxic materials and can rupture or leak if mistreated. Remove rings and metal wristwatches or other metal objects and jewelry. Do not carry metal objects in your pockets where the objects can fall into the battery cabinet.
2. Tools must have insulated handles and must be insulated so that they will not short battery terminals. Do not allow a tool to short between individual or separate battery terminals or to the cabinet or rack. Do not lay tools or metal parts on top of the batteries, and do not lay them where they could fall onto the batteries or into the cabinet.
3. Install the batteries as shown on the drawing provided with the batteries. When connecting cables, never allow a cable to short across a battery's terminals, the string of batteries, or to the cabinet or rack.
4. Align the cables on the battery terminals so that the cable lug will not contact any part of the cabinet or rack, even if the battery is moved. Keep the cable away from any sharp metal edges.
5. Install the battery cables so they cannot be pinched by the UPS or battery cabinet doors.

## **A DANGER!**

6. Do not connect the battery terminal to ground (earth). If any battery terminal is inadvertently grounded, remove the source of the ground. Contacting any part of a grounded battery can cause a risk of electric shock.
7. To reduce the risk of fire or electric shock, install the batteries in a temperature and humidity controlled, indoor area, free of contaminants.
8. Battery cabinet chassis ground (earth) must be connected to the UPS chassis ground (earth). If you use conduit, this ground conductor must be routed in the same conduit as the battery conductors.
9. Where conductors may be exposed to physical damage, protect the conductors in accordance with all applicable codes.
10. If you are replacing batteries or repairing battery connections, shut off the UPS and remove both AC and DC power.

Follow these guidelines when installing the batteries:

- Refer to any instructions provided with the batteries.
- Refer to any instructions provided with the DC disconnect (DCD) and pre-charge/discharge switch.
- External batteries require a fused disconnect or a DC circuit breaker. There should be a disconnecting means for each battery string. The external battery fuse protects the battery cables. Size the cables based on the overcurrent protection device.
- The battery cables must be sized for a total maximum voltage drop of 2.0 VDC at the rated DC current.
- Wherever conductors may be exposed to physical damage, protect the conductors in accordance with any applicable codes. This includes battery cables between the UPS and the battery system and cables between battery cabinets or racks.
- BEST recommends routing battery cables through flexible conduit. Install flexible conduit for battery cables according to local or national code.
- The battery system ground (earth) must be connected to the UPS chassis ground (earth). This ground conductor must be routed with the battery cables.

<p style="text-align: center;"><b>UT3120, UT3160, and UT3220</b> <b>Planning and Installation Manual</b></p>
--

- Clean the cables and battery terminals before making the battery connections. Apply a thin coating of conductive grease before making the battery connections or, after making connections, apply petroleum jelly to the entire connection.
- ⊕ Torque battery connections to the battery manufacturer's specifications.

Follow the steps below and any instructions provided with the battery system:

1. Connect the cables **between batteries**.
  - a. In each **battery** string, connect the cables between batteries as shown in the battery installation diagram provided with the batteries.
  - b. Meter the positive (+) and negative (-) terminal on each battery string to verify proper nominal voltage and polarity.
2. Connect the battery cables **between battery strings**.
  - a. Connect the negative (-) cables between battery strings as shown in the battery installation diagram provided with the batteries.
  - b. Meter the DC voltage between the positive terminals of the strings. The voltage should measure less than 5 volts. If it measures greater than 5 volts, correct any wiring errors before you continue.
  - c. Connect the positive (+) cables between battery strings as shown in the battery installation diagram provided with the batteries.
3. Install the DC disconnect (DCD) and pre-charge/discharge switch. Refer to Figure 4 or 5 and to any instructions provided with the DCD and pre-charge/discharge switch.
4. Connect the external batteries to the UPS.
  - a. Connect the positive (+) cable(s) to the UPS first. Install ring connectors for 12 mm bolts as required.
  - b. To prevent short circuits, insulate the UPS end of the negative (-) cable(s).  
**Do not connect the negative (-) cables to the UPS yet.**
  - c. Connect the positive (+) cable(s) to the battery system and tighten to the proper torque specifications.
  - d. Connect the negative (-) cable(s) to the battery system and tighten to the proper torque specifications.



<p style="text-align: center;"><b>UT3120, UT3160, and UT3220 Planning and Installation Manual</b></p>
---

5. Check the DC voltage.
  - a. Connect the DC fuse(s) as shown in the battery installation diagram provided with the batteries. Verify proper voltage (408 VDC nominal) and polarity at the battery pack.
  - b. Turn the DC disconnect (DCD) “ON.”
  - c. Meter for proper nominal DC voltage at the UPS end of the cables. Make sure the polarity agrees with the markings on the UPS battery input terminals.
  - d. After checking the DC voltage, turn the DC disconnect (DCD) “OFF.”
6. Connect the negative (-) cable(s) to the UPS. Tighten to the proper torque specifications.
7. Replace all covers.
8. Continue with Section 300, “Initial Startup and Phase Check.”

### **Battery Replacement Information**

Only a qualified service person familiar with battery systems should replace batteries. See Section 500, “Shutdown Procedure,” to bypass and shut down the UPS.

**Review all of the warnings at the beginning of Section 202 before replacing the batteries.**

- **Use the Same Number and Type of Battery:** To ensure continued superior performance of your UPS and to maintain proper battery charger operation, you must replace the batteries with the same number of batteries. The batteries must be the same manufacturer type as the original batteries and have the same voltage and ampere-hour rating as the original batteries.
- **Verify that the Battery Terminal is Not Grounded:** If any battery terminal is inadvertently grounded, you must remove the connection from the terminal to ground (earth) before you service the batteries. Contacting any part of a grounded battery can cause a risk of electric shock. An electric shock will be less likely if you disconnect the ground connection before you service the batteries.
- **Handle Used Batteries with Care:** Assume that old batteries are fully charged. Use the same precautions you would use when handling a new battery. Do not short battery terminals or the battery string with a cable or tool when you disconnect the batteries.

- **Dispose of Batteries Properly:** For assistance, call BEST's Technical Support Center at 1-800-356-5737 (U.S.A. or Canada) or call your local BEST office.



### **WARNING!**

Do not dispose of batteries in a fire because the batteries could explode.

Do not open or mutilate batteries. Released electrolyte is harmful to the skin and eyes and may be toxic.

Batteries contain lead. Many state and local governments have regulations about disposing of used batteries. Dispose of batteries properly. For assistance, call BEST's Technical Support at 1-800-356-5737 or call your local BEST office.

---

## **Section 300: Initial Startup and Phase Check**

---



### **WARNING!**

Some units have been programmed at the factory for "autostart." If programmed for "autostart," the unit will turn on **any time** mains (AC line) is applied (after a 60-second delay). For more information or to change this feature, see the user manual.

Before continuing, read the warnings on the inside front cover of this manual.

After installing the unit, use this section to perform the initial startup and the phase check for the Maintenance Bypass Cabinet (MBC).

The steps in this section are for a unit with a BEST-supplied MBC.

#### **Follow this Procedure Exactly! No Load Should Be Applied!**

1. Make sure that all AC and DC power is off.
2. Switch the maintenance bypass breaker (MBB) "OFF."
3. Switch the UPS output breaker (UOB) "OFF."

**UT3120, UT3160, and UT3220  
Planning and Installation Manual**

4. At the mains AC input service panel, switch on the input power to the UPS and MBC.
5. Switch the UPS input breaker (UIB) “ON.” The display should show System type xxkVA xxxV.
6. Within 20 seconds, the display should show \*\*Stand-by\* \* and an audible **alarm** should sound.
7. Turn the pre-charge/discharge switch to the “pre-charge” position and hold it until the LED turns off.
8. Switch the battery DC disconnect (DCD) “ON”.
9. Check the phase rotation at the service panel and the unit. The unit will not start if the rotation is incorrect. **The phase rotation must be A, B, C and clockwise.**
10. When the audible alarm stops, press the green “on” button located inside the UPS front door. The UPS display will show Normal operation load power xx%.

**NOTE:** One or more alarms may occur. If the alarm(s) persists for more than 20 seconds, refer to the “Alarms” section of the user manual. If the unit activates a “battery monitor alarm,” you should set the user parameter “battery monitor reset” to “ON.”





11. If the UPS is connected to a generator, verify that the unit operates properly on generator power before continuing. If the UPS operates properly on generator power, continue this procedure. If the UPS does not operate properly on generator power, phone BEST’s Technical Support Center for assistance.



## **CAUTION**

**Before** you switch the maintenance bypass breaker (MBB) “ON,” use the steps below to check for correct voltage, phasing, and system operating mode.

12. Program the unit into static bypass operation:

- a. Press  to access the user parameters.
- b. Press the  or  key until the display shows Bypass operation: OFF.
- c. Press  to turn static bypass operation on. The display should show Bypass operation.

13. Switch the UPS output breaker (UOB) “ON.”

<b>UT3120, UT3160, and UT3220</b> <b>Planning and Installation Manual</b>
--

14. At the MBC, make sure that the UPS output voltage is approximately the same as the AC line input voltage (there may be slight differences). Use a true RMS voltmeter to measure the phase-to-neutral voltage (**only for 4-wire inputs**) at the MBC AC line input and the MBC output.

<b>MBC AC Line Input</b>	<b>MBC Output to Loads</b>
a. <i>L1 to neutral</i> _____ VAC	<i>L1 to neutral</i> _____ VAC
b. <i>L2 to neutral</i> _____ VAC	<i>L2 to neutral</i> _____ VAC
c. <i>L3 to neutral</i> _____ VAC	<i>L3 to neutral</i> _____ VAC

The voltages in the first column should be similar to the voltages in the second column. If the voltages are more than 25 volts apart, check the connections and correct any wiring problems before continuing.

15. At the MBC, make sure the UPS output voltage and AC line input voltage are in phase. To do this, measure the AC voltage between the following points at the MBC AC line input and the MBC output:

<b>MBC AC Line Input</b>		<b>MBC Output to Loads</b>
a. <i>L1 input</i>	to	<i>L1 output</i> _____ VAC
b. <i>L2 input</i>	to	<i>L2 output</i> _____ VAC
c. <i>L3 input</i>	to	<i>L3 output</i> _____ VAC

**These readings must not be more than 25 VAC.** If they are, call BEST’s Technical Support Center or your local BEST office.

16. At the MBC, measure the following:

a. <i>N input to Ground</i> _____ VAC
b. <i>N output to Ground</i> _____ VAC
c. <i>N input to N output</i> _____ VAC

“*N input to N output*” should not exceed “*N input to Ground.*” If it does, call BEST’s Technical Support Center.

17. Check for proper voltages at the MBC load output terminals and the load distribution panel(s) (**only for 4-wire inputs**).

<b>MBC Output to Loads</b>	<b>Load Panel Input</b>
a. <i>L1 to neutral</i> _____ VAC	<i>L1 to neutral</i> _____ VAC
b. <i>L2 to neutral</i> _____ VAC	<i>L2 to neutral</i> _____ VAC
c. <i>L3 to neutral</i> _____ VAC	<i>L3 to neutral</i> _____ VAC

18. Switch the maintenance bypass breaker (MBB) “ON.”
19. Switch the UPS output breaker (UOB) “OFF.”

**UT3120, UT3160, and UT3220  
Planning and Installation Manual**





20. Recheck for proper voltages at the MBC load output terminals and load distribution panel(s)

<b>MBC Output to Loads</b>	<b>Load Panel Input</b>
a. L1 to neutral _____ VAC	L1 to neutral _____ VAC
b. L2 to neutral _____ VAC	L2 to neutral _____ VAC
c. L3 to neutral _____ VAC	L3 to neutral _____ VAC

21. Switch the UPS output breaker (UOB) “ON.”

22. Switch the maintenance bypass breaker (MBB) “OFF.”

23. Program the UPS to normal operation:

- a. Press  to access the user parameters.
- b. Press the  or  key until the UPS display shows Bypass operation: ON.
- c. Press  to turn static bypass operation off. The UPS display should show Normal operation load power xx%.



The system is now ready to use. As the last step of the installation, BEST recommends that you clear the events log. See Section 400, “Clearing the Events Log.”

---

## Section 400: Clearing the Events Log

---

The events log contains the 250 most recent UPS events, including alarms. To clear the events log, follow the steps below:

1. Simultaneously press  and . The display should show Key in password.
2. Using the key pad, enter “920701.” The display should show Logging stack is reset . The events log is now cleared.

If the unit will not be used immediately, go to Section 500, “Shutdown Procedure.”

## Section 500: Shutdown Procedure



### WARNING!





After shutting down the unit, **wait at least five minutes** before removing any access panels or covers. Access panels should be removed by **qualified service personnel** only.

After shutting down the UPS, there may still be high voltage inside the unit.

### TEST BEFORE TOUCHING!

Before continuing, read the warnings on the inside front cover of this manual.

This section tells how to shut down the UPS from normal operation mode. This procedure is for a unit with a BEST maintenance bypass cabinet (MBC).

1.
  - **If you have shut the loads down:** Skip to step 4.
  - **If the loads are to remain powered:** Program the unit into static bypass operation:
    - a. Press  to access the user parameters.
    - b. Press the  or  key until the display shows `Bypass operation: OFF`.
    - c. Press  to turn static bypass operation on. The display should show `Bypass operation`.
2. Switch the maintenance bypass breaker (MBB) “ON”.
3. Switch the UPS output breaker (UOB) “OFF”.
4. Press the red “off” button located inside the UPS front door.
5. Switch the UPS input breaker (UIB) “OFF”
6. Switch the DC disconnect (DCD) “OFF.”
7. Turn the pre-charge/discharge switch to the “discharge” position and hold it until the LED turns off. The UPS display should now be blank.

To restart the unit, see Section 600, “Startup from Maintenance Bypass.”









8. (Optional) If the loads are **not** to be powered, turn off all AC power sources to the UPS and MBC.

---

## **Section 600: Startup from Maintenance Bypass**

---

This section tells how to start the UPS from maintenance bypass. The steps in this procedure are for a unit with a BEST maintenance bypass cabinet (MBC).

1. Make sure that the following switches are in the following positions:
  - The UPS input breaker (UIB) should be “OFF.”
  - The UPS output breaker (UOB) should be “OFF.”
  - The UPS maintenance bypass breaker (MBB) should be “ON.”
  - The DC disconnect (DCD) should be “OFF.”
2. Switch the UPS input breaker (UIB) “ON.” The UPS display should show System type `xxkVA xxxV`.
3. Within 20 seconds, the display should show `**St and-by* *` and an audible alarm should sound.
4. Turn the pre-charge/discharge switch to the “pre-charge” position and hold it until the LED turns off.
5. Switch the DC disconnect (DCD) “ON.”
6. Press the green “on” button located inside the UPS front door. The UPS display should show Normal operation load power `xx%`.
7. Program the UPS into static bypass operation:
  - a. Press  to access the user parameters.
  - b. Press the  or  key until the display shows `Bypass operation: OFF`.
  - c. Press  to turn bypass operation on. The display should show `Bypass operation`.
8. Switch the UPS output breaker (UOB) “ON.”
9. Switch the maintenance bypass breaker (MBB) “OFF.”
10. Program the unit to normal operation:
  - a. Press  to access the user parameters.
  - b. Press the  or  key until the UPS display shows `Bypass operation: ON`.
  - c. Press  so **switch** static bypass operation off, The UPS display should show Normal operation load power `xx%`.

---

## **Section 700: Glossary of Terms and Abbreviations**

---

Section 701 contains a glossary of terms. Section 702 contains a list of abbreviations.

---

### **701 Glossary of Terms**

---

**Ampere (Amp):** A unit of electric current equivalent to a steady current produced by one volt applied across a resistance of one ohm.

**British thermal unit (BTU):** A unit of heat energy equal to the heat needed to raise the temperature of one pound of air-free water from 60° to 61° F at a constant pressure of one standard atmosphere.

**Decibel adjusted (dBa):** A unit used to show the relationship between an acoustic noise source and a reference sound power level of -85 dBm.

**Ground (Earth):** A conducting connection, whether intentional or accidental, by which an electric circuit or equipment is connected to earth or to some conducting body that serves in place of earth.

**Load tolerance - symmetrical:** Equally balanced loads on a three-phase system.

**Load tolerance - asymmetrical:** Unbalanced loads on a three-phase system.

**Mains:** The conductors extending from the service switch, generator bus, or converter bus to the main distribution center in interior wiring. Synonymous with power source (input line).

**Noise attenuation - differential mode:** The ability to attenuate noise, line to line

**Noise attenuation - common mode:** The ability to attenuate noise, line to ground and neutral to ground

**Nominal voltage:** The voltage at which a device operates under ideal conditions,

**Power factor (PF):** The ratio of the **true** (real) power to the apparent power: root means-square (RMS) voltage times RMS current of an alternating current circuit.

**Protective earth (PE):** Synonymous with grounding electrode conductor

**Static switch:** An electronic switch that has no moving parts.

---

### **702 Abbreviations**

---

BCA	Battery cabinet assembly
DCD	DC disconnect switch (may be a separate switch or a switch located on the battery cabinet/rack)
MBB	Maintenance bypass breaker
MBC	Maintenance bypass cabinet
MIB	Main input breaker
MOB	Main output breaker
SKRU	Solenoid key release unit
UIB	UPS input breaker
UOB	UPS output breaker





