

Eaton® 93PM UPS

20–100 kW (480V) – 100 kW Frame
Installation and Operation Manual



Powering Business Worldwide

Eaton® 93PM UPS

20–100 kW (480V) – 100 kW Frame
Installation and Operation Manual



Powering Business Worldwide

IMPORTANT SAFETY INSTRUCTIONS SAVE THESE INSTRUCTIONS

This manual contains important instructions that you should follow during installation and maintenance of the UPS and batteries. Please read all instructions before operating the equipment and save this manual for future reference.

CONSIGNES DE SÉCURITÉ IMPORTANTES CONSERVER CES INSTRUCTIONS

Ce manuel comporte des instructions importantes que vous êtes invité à suivre lors de toute procédure d'installation et de maintenance des batteries et de l'onduleur. Veuillez consulter entièrement ces instructions avant de faire fonctionner l'équipement et conserver ce manuel afin de pouvoir vous y reporter ultérieurement.

Eaton, Powerware, and Mini-Slot are registered trademarks and ConnectUPS is a trademark of Eaton Corporation or its subsidiaries and affiliates. Modbus is a registered trademark of Schneider Electric. National Electrical Code and NEC are registered trademarks of National Fire Protection Association, Inc. All other trademarks are property of their respective companies.

©Copyright 2013–2015 Eaton Corporation, Raleigh, NC, USA. All rights reserved. No part of this document may be reproduced in any way without the express written approval of Eaton Corporation.

Table of Contents

1	INTRODUCTION	1-1
1.1	UPS Standard Features	1-1
1.1.1	Installation Features	1-1
1.1.2	Control Panel	1-3
1.1.3	Customer Interface	1-3
1.1.4	Energy Saver System Mode	1-3
1.1.5	Internal Redundancy	1-3
1.1.6	Advanced Battery Management	1-3
1.2	Options and Accessories	1-4
1.2.1	Integrated Battery Cabinet	1-4
1.2.2	Integrated Accessory Cabinet-Distribution	1-4
1.2.3	Sidecar Integrated Accessory Cabinet-Bypass	1-4
1.2.4	Sidecar Integrated Accessory Cabinet-Tie	1-4
1.2.5	Sidecar Integrated Accessory Cabinet-Tie Bypass	1-5
1.2.6	Integrated Accessory Cabinet-Tie	1-5
1.2.7	Parallel System	1-5
1.2.8	Top Entry Wiring Sidecar	1-5
1.2.9	Monitoring and Communication	1-5
1.2.10	Additional Output Surge Protection	1-5
1.3	Battery System	1-5
1.4	Basic System Configurations	1-6
1.5	Using This Manual	1-6
1.6	Conventions Used in This Manual	1-6
1.7	Symbols, Controls, and Indicators	1-7
1.8	For More Information	1-8
1.9	Getting Help	1-9
2	SAFETY WARNINGS	2-1
SECTION 1 — INSTALLATION		
3	UPS INSTALLATION PLAN AND UNPACKING	3-1
3.1	Creating an Installation Plan	3-1
3.2	Preparing the Site	3-1
3.2.1	Environmental and Installation Considerations	3-1
3.2.2	UPS System Power Wiring Preparation	3-13
3.2.3	External Parallel UPS System Power Wiring Preparation	3-14
3.2.4	UPS System Interface Wiring Preparation	3-25
3.3	Inspecting and Unpacking the UPS Cabinets	3-26
4	UPS SYSTEM INSTALLATION	4-1
4.1	Preliminary Installation Information	4-1
4.2	Unloading the UPS Cabinet from the Pallet	4-1
4.3	Integrated Battery Cabinet Installation	4-5
4.4	Sidecar Integrated Accessory Cabinet-Bypass Wiring Installation	4-5
4.5	Sidecar Integrated Accessory Cabinet-Tie Wiring Installation	4-6
4.6	Sidecar Integrated Accessory Cabinet-Tie Bypass Wiring Installation	4-6

Table of Contents

4.7	Integrated Accessory Cabinet-Tie	4-6
4.8	Integrated Accessory Cabinet-Distribution	4-6
4.9	External AC Power Wiring Installation	4-6
4.10	Battery Power Wiring	4-12
4.11	Installing Interface Connections	4-13
4.11.1	Installing Building Alarm and Relay Contact Connections	4-13
4.11.2	Installing Battery Detect Interface Connections	4-18
4.11.3	Installing Battery Shunt Trip Interface Connections	4-19
4.11.4	Generator Interface Connections	4-23
4.11.5	Installing External Parallel CAN Control Wiring and Connections	4-24
4.11.6	Installing External Parallel Pull Chain Control Wiring and Connections	4-27
4.11.7	Installing Minislot Interface Connections	4-28
4.12	Installing a REPO Switch	4-30
4.13	Initial Startup	4-33
4.14	Completing the Installation Checklist	4-33
SECTION 2 — OPERATION		
5	UNDERSTANDING UPS OPERATION	5-1
5.1	UPS System Overview	5-1
5.2	Single UPS	5-1
5.2.1	Modes	5-2
5.2.2	Energy Saver System Mode	5-2
5.2.3	Normal Mode	5-3
5.2.4	Bypass Mode	5-4
5.2.5	Battery Mode	5-5
5.3	Single UPS Unit System Online Configurations	5-7
6	UPS OPERATING INSTRUCTIONS	6-1
6.1	UPS Controls and Indicators	6-1
6.2	Using the Control Panel	6-2
6.2.1	Status Indicators	6-3
6.2.2	System Events	6-3
6.2.3	Using the LCD Touch Screen	6-4
6.2.4	Using the Menu	6-5
6.2.5	Mimic Screen	6-5
6.2.6	Display Menu Operation	6-6
6.2.7	Sign In	6-12
6.2.8	System Controls	6-13
6.3	Single UPS Operation	6-16
6.3.1	Starting the UPS in Double Conversion Mode	6-16
6.3.2	Starting the UPS in Bypass Mode	6-16
6.3.3	Starting the UPMs	6-17
6.3.4	Starting a Single UPM	6-17
6.3.5	Transfer from Double Conversion to Bypass Mode	6-18
6.3.6	Transfer from Bypass to Double Conversion Mode	6-18
6.3.7	Transfer from ESS Mode to Double Conversion Mode	6-18
6.3.8	Transfer from Double Conversion Mode to ESS Mode	6-19
6.3.9	Transfer from Double Conversion to Bypass Mode and Shut Down UPMs	6-19

- 6.3.10 Single UPM Shutdown 6-19
- 6.3.11 Single UPM Restart 6-20
- 6.3.12 UPS and Critical Load Shutdown 6-20
- 6.3.13 Charger Control 6-20
- 6.3.14 Battery Test 6-21
- 6.3.15 Using the UPS LOAD OFF Command 6-21
- 6.3.16 Using the Remote Emergency Power-off Switch 6-22
- 6.4 Multiple External Parallel System Operation 6-23
 - 6.4.1 Starting the Parallel System in Double Conversion Mode 6-23
 - 6.4.2 Starting the Parallel System in Bypass Mode 6-24
 - 6.4.3 Starting the Parallel System UPMs 6-24
 - 6.4.4 Starting a Single UPM 6-25
 - 6.4.5 Transfer from Double Conversion to Bypass Mode 6-25
 - 6.4.6 Transfer from Bypass to Double Conversion Mode 6-25
 - 6.4.7 Transfer from ESS Mode to Double Conversion Mode 6-26
 - 6.4.8 Transfer from Double Conversion Mode to ESS Mode 6-26
 - 6.4.9 Transfer from Double Conversion to Bypass Mode and Shut Down all UPMs 6-26
 - 6.4.10 Single UPM Shutdown 6-26
 - 6.4.11 Single UPM Restart 6-27
 - 6.4.12 Single UPS Shutdown 6-27
 - 6.4.13 Single UPS Restart 6-28
 - 6.4.14 Parallel System and Critical Load Shutdown 6-29
 - 6.4.15 Charger Control 6-29
 - 6.4.16 Battery Test 6-29
 - 6.4.17 Using the LOAD OFF Command 6-30
 - 6.4.18 Using the Remote Emergency Power-off Switch 6-31
- 7 COMMUNICATION 7-1**
 - 7.1 Minislot Cards 7-1
 - 7.2 Building Alarm Monitoring 7-2
 - 7.3 General Purpose Relay Contact 7-2
 - 7.4 Predict Pulse Remote Monitoring and Management Service 7-2
 - 7.4.1 PredictPulse Service Features 7-2
 - 7.4.2 Installing PredictPulse 7-3
- 8 UPS MAINTENANCE 8-1**
 - 8.1 Important Safety Instructions 8-1
 - 8.2 Performing Preventive Maintenance 8-2
 - 8.2.1 DAILY Maintenance 8-2
 - 8.2.2 MONTHLY Maintenance 8-2
 - 8.2.3 ANNUAL Maintenance 8-3
 - 8.2.4 BATTERY Maintenance 8-3
 - 8.3 Installing Batteries 8-4
 - 8.4 Recycling the Used Battery or UPS 8-4
 - 8.5 Maintenance Training 8-4

Table of Contents

9	PRODUCT SPECIFICATIONS	9-1
9.1	Model Numbers	9-1
9.2	Specifications	9-1
9.2.1	UPS Input	9-1
9.2.2	UPS Output	9-2
9.2.3	UPS Environmental	9-2
	WARRANTY	W-1

List of Figures

Figure 1-1.	Eaton 93PM UPS (20–100 kW)	1-2
Figure 1-2.	Eaton 93PM UPS (20–100 kW) with Left or Right Mounted Sidecar	1-2
Figure 3-1.	UPS Cabinet Dimensions (Front and Right Side Views)	3-5
Figure 3-2.	UPS Cabinet Dimensions (Top and Bottom Views).	3-6
Figure 3-3.	UPS Cabinet Front and Back Floor Mounting Bracket Mounting Dimensions (Back Views).	3-7
Figure 3-4.	UPS Cabinet with Left-Mounted or Right-Mounted Sidecar Dimensions (Front and Right Side Views)	3-8
Figure 3-5.	UPS Cabinet with Left-Mounted or Right-Mounted Sidecar Dimensions (Top and Bottom Views)	3-9
Figure 3-6.	UPS Cabinet Center of Gravity	3-10
Figure 3-7.	UPS Cabinet with Left-Mounted or Right-Mounted Sidecar Center of Gravity	3-11
Figure 3-8.	Remote EPO Switch Dimensions	3-12
Figure 3-9.	93PM External Parallel Wire Length	3-15
Figure 3-10.	UPS Cabinet as Shipped on Pallet.	3-27
Figure 3-11.	UPS Cabinet with Left-Mounted or Right-Mounted Sidecar as Shipped on Pallet	3-28
Figure 4-1.	Removing the Pallet Skids and Supports – Eaton 93PM UPS.	4-2
Figure 4-2.	Removing the Sidecar Pallet Skids and Supports – Eaton 93PM UPS	4-3
Figure 4-3.	Removing the Sidecar Rear Shipping Bracket – Eaton 93PM UPS.	4-5
Figure 4-4.	UPS Conduit and Wire Entry Locations	4-8
Figure 4-5.	Sidecar Conduit and Wire Entry Locations	4-9
Figure 4-6.	UPS Inter-Cabinet Wiring Access Location	4-10
Figure 4-7.	Power Terminal Locations	4-11
Figure 4-8.	Power Terminal Detail	4-12
Figure 4-9.	Interface Terminal Locations	4-15
Figure 4-10.	Interface Terminal Detail	4-16
Figure 4-11.	Bottom Access Interface Wiring Location.	4-16
Figure 4-12.	Wire Tie Anchors	4-17
Figure 4-13.	Building Alarm Terminal Block Connector Assignments	4-17
Figure 4-14.	Relay Contact Terminal Block Connector Assignments	4-18
Figure 4-15.	Battery Shunt Trip Location.	4-21
Figure 4-16.	Battery Shunt Trip Terminal Detail.	4-22
Figure 4-17.	Battery Shunt Trip Terminal Assignments.	4-22
Figure 4-18.	External Parallel CAN Wiring	4-26
Figure 4-19.	External Parallel Terminal Block.	4-26
Figure 4-20.	External Parallel Pull Chain Wiring.	4-29
Figure 4-21.	REPO Switch.	4-31
Figure 4-22.	REPO Terminal Block Connector Assignments.	4-31
Figure 4-23.	Normally-Open REPO Switch Wiring.	4-32
Figure 4-24.	Normally-Closed REPO Switch Wiring	4-32
Figure 5-1.	Main Elements of the UPS System.	5-1
Figure 5-2.	Path of Current Through the UPS in Energy Saver System Mode	5-3
Figure 5-3.	Path of Current Through the UPS in Normal Mode.	5-4
Figure 5-4.	Path of Current Through the UPS in Bypass Mode.	5-5
Figure 5-5.	Path of Current Through the UPS in Battery Mode.	5-6
Figure 5-6.	Eaton 93PM-100-1 UPS System Oneline	5-8
Figure 5-7.	Eaton 93PM-100-1 UPS System with Two-Breaker Bypass Oneline	5-9
Figure 5-8.	Eaton 93PM-100-1 UPS System with Three-Breaker Bypass Oneline	5-10
Figure 5-9.	Eaton 93PM-100-1 UPS System with Four-Breaker Bypass Oneline	5-11

List of Figures

- Figure 5-10. Eaton 93PM-100-2 UPS System Oneline 5-12
- Figure 5-11. Eaton 93PM-100-2 UPS System with Two-Breaker Bypass Oneline 5-13
- Figure 5-12. Eaton 93PM-100-2 UPS System with Three-Breaker Bypass Oneline 5-14
- Figure 5-13. Eaton 93PM-100-2 UPS System with Four-Breaker Bypass Oneline 5-15
- Figure 5-14. Eaton 93PM-100-3 UPS System Oneline 5-16
- Figure 5-15. Eaton 93PM-100-3 UPS System with Two-Breaker Bypass Oneline 5-17
- Figure 5-16. Eaton 93PM-100-3 UPS System with Three-Breaker Bypass Oneline 5-18
- Figure 5-17. Eaton 93PM-100-3 UPS System with Four-Breaker Bypass Oneline 5-19
- Figure 6-1. UPS Controls and Indicators 6-1
- Figure 6-2. UPS Control Panel. 6-2
- Figure 6-3. Parts of the LCD 6-4
- Figure 6-4. Main Menu and Mimic Screen 6-5
- Figure 6-5. Typical Meters Summary Screen 6-7
- Figure 6-6. Typical Active Events Screen 6-7
- Figure 6-7. Typical System Log Screen. 6-8
- Figure 6-8. Typical Settings User Screen 6-8
- Figure 6-9. Typical Information Screen 6-9
- Figure 6-10. Typical About Screen 6-9
- Figure 6-11. Typical Settings Configuration 1 Screen 6-10
- Figure 6-12. Typical Settings Configuration 2 Screen 6-10
- Figure 6-13. Typical Statistics Screen 6-11
- Figure 6-14. Sign In Password Screen 6-12
- Figure 6-15. Sign In Keypad 6-12
- Figure 6-16. Typical System Control Screen 6-13
- Figure 6-17. Typical UPS Control Screen 6-14
- Figure 6-18. Typical UPM Select Screen. 6-14
- Figure 6-19. Typical UPM Control Screen 6-15
- Figure 6-20. Typical EAA Control Screen 6-15
- Figure 6-21. REPO Operation 6-22
- Figure 7-1. Optional Minislot Cards. 7-1
- Figure 8-1. Air Filter Location 8-3

List of Tables

Table 3-1.	Air Conditioning or Ventilation Requirements During Full Load Operation	3-2
Table 3-2.	UPS Cabinet Weights	3-3
Table 3-3.	UPS Cabinet Clearances	3-4
Table 3-4.	Input/Output Ratings and External Wiring Requirements for the Eaton 93PM-100-1 and 93PM-100-2 (N+1)	3-16
Table 3-5.	Input/Output Ratings and External Wiring Requirements for the Eaton 93PM-100-2 and 93PM-100-3 (N+1)	3-17
Table 3-6.	UPS External Power Cable Terminations for the Eaton 93PM-100-1, 93PM-100-2, and 93PM-100-3	3-18
Table 3-7.	Power Cable Conduit Requirements for the Eaton 93PM-100-1 and Eaton 93PM-100-2 (N+1)	3-19
Table 3-8.	Power Cable Conduit Requirements for the Eaton 93PM-100-2 and Eaton 93PM-100-3 (N+1)	3-20
Table 3-9.	Recommended Input and Bypass Circuit Breaker Ratings	3-21
Table 3-10.	Recommended Output Circuit Breaker Ratings	3-22
Table 3-11.	Recommended DC Input Battery Disconnect Circuit Breaker Ratings (216 Cell)	3-23
Table 3-12.	Recommended DC Input Battery Disconnect Circuit Breaker Ratings (240 Cell)	3-24
Table 4-1.	Building Alarm Connections and Wire Terminations	4-17
Table 4-2.	Relay Contact Connections and Wire Terminations	4-18
Table 4-3.	Battery Shunt Trip Connections and Wire Terminations	4-22
Table 4-4.	External Parallel CAN and Pull Chain Connections	4-25
Table 4-5.	External Parallel CAN and Pull Chain Terminal Block Terminations	4-25
Table 4-6.	Normally-Open REPO Connections and Wire Terminations	4-32
Table 4-7.	Normally-Closed REPO Connections and Wire Terminations	4-32
Table 6-1.	Status Indicators	6-3
Table 6-2.	Display Function Menu Map	6-5
Table 6-3.	Display Menu Operation	6-6
Table 6-4.	Controls Menu Operation	6-13
Table 6-5.	Typical System Status Messages	6-13
Table 7-1.	IRC-MS Default Triggers	7-1

This page intentionally left blank.

Chapter 1 Introduction

The Eaton® 93PM 20–100 kW uninterruptible power supply (UPS) is a true online, continuous-duty, transformerless, double-conversion, solid-state, three-phase system, providing conditioned and uninterruptible AC power to protect the customer's load from power failures.

The Eaton 93PM 20–100 kW online power protection system is used to prevent loss of valuable electronic information, minimize equipment downtime, and minimize the adverse effect on production equipment due to unexpected power problems.

The Eaton 93PM 20–100 kW UPS continually monitors incoming electrical power and removes the surges, spikes, sags, and other irregularities that are inherent in commercial utility power. Working with a building's electrical system, the UPS system supplies clean, consistent power that sensitive electronic equipment requires for reliable operation. During brownouts, blackouts, and other power interruptions, batteries provide emergency power to safeguard operation.

The Eaton 93PM 20–100 kW UPS is available with one, two, or three Uninterruptible Power Modules (UPMs) integrated in one cabinet. Each UPM is rated for a maximum of 50 kW. The system maximum rating is 100 kW. To deliver greater reliability, UPS with two or three UPMs can provide N+1 redundancy up to a maximum of 50 kW and 100 kW respectively. Should one UPM become unavailable or require servicing, the remaining UPM supplies the load instead of transferring to bypass.

The UPS is housed in a single free-standing cabinet, with safety shields behind the door for hazardous voltage protection. Power wiring is installed through the bottom of the cabinet with an optional sidecar available for top entry wiring. Figure 1-1 shows the Eaton 93PM 20–100 kW UPS and Figure 1-2 shows the Eaton 93PM 20–100 kW UPS with a left or right mounted sidecar.

NOTE  Startup and operational checks must be performed by an authorized Eaton Customer Service Engineer, or the warranty terms specified on page W-1 become void. This service is offered as part of the sales contract for the UPS. Contact an Eaton service representative in advance (a minimum two-week notice is required) to reserve a preferred startup date.

1.1 UPS Standard Features

The UPS has many standard features that provide cost-effective and consistently reliable power protection. The descriptions in this section provide a brief overview of the UPS standard features.

1.1.1 Installation Features

- Line-up-and-match or standalone configurations
- Power wiring can be routed through the bottom of the cabinet
- Battery wiring can be run internally through the left or right sides of the UPS cabinet in line-up-and-match configurations
- Easily accessible mechanical terminals located at the bottom front of the cabinet reduce installation time
- Control wiring can be routed through the top or bottom of the UPS cabinet, or through the left or right sides of the UPS cabinet in line-up-and-match configurations
- Built-in casters for easy cabinet placement
- Cabinet bolt holes are provided for permanently mounting the UPS using optional front and back or left and right side floor mounting bracket kits.

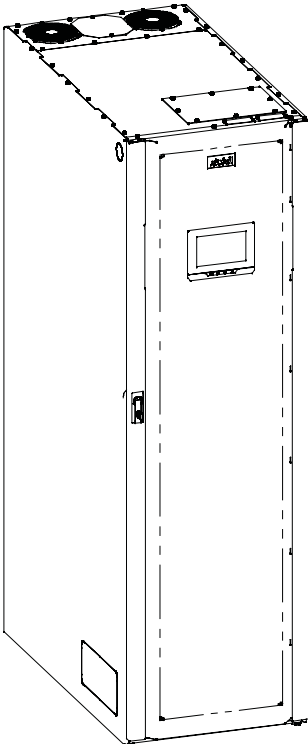
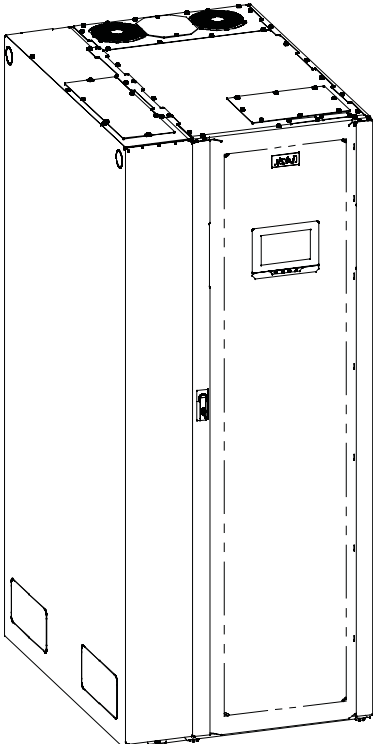
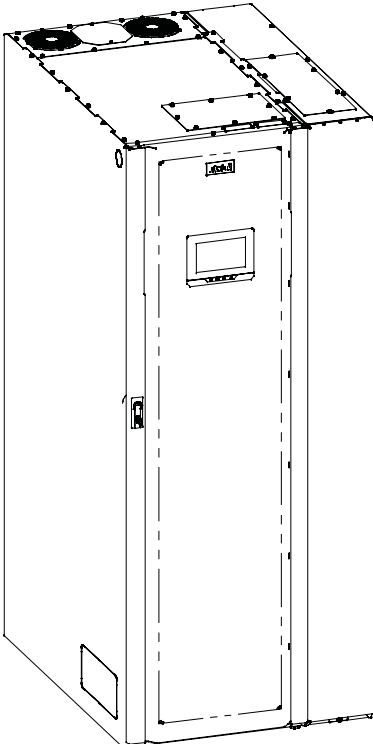

Figure 1-1. Eaton 93PM UPS (20–100 kW)



UPS with Left-Mounted Sidecar



UPS with Right-Mounted Sidecar

Figure 1-2. Eaton 93PM UPS (20–100 kW) with Left or Right Mounted Sidecar

1.1.2 Control Panel

The control panel, located on the front of the UPS, contains a color liquid crystal touch screen display (LCD) and a horizontal row of LED indicators to control the operation of the UPS and to display the status of the UPS system. See Chapter 6, “UPS Operating Instructions,” for additional information.

1.1.3 Customer Interface

- **Building Alarm Monitoring** – Up to five inputs in the UPS are available to connect the facility's alarm system contacts. Some system configurations may limit the number of inputs available. The UPS uses these inputs to monitor the building alarms in addition to the UPS status. See Chapter 7, “Communication,” for additional information.
- **Alarm Contact** – One alarm contact is provided for connection to equipment at the facility, such as a light, an audible alarm, or a computer terminal. The equipment connected to this contact alerts you to a UPS alarm. See Chapter 7, “Communication,” for additional information.
- **Minislot Communication Bays** – Four communication bays are standard equipment. One to four optional Minislot® connectivity cards can be installed in the UPS at any time. Minislot cards are quickly installed at the front of the UPS and are hot-pluggable. See Chapter 7, “Communication,” for additional information.

1.1.4 Energy Saver System Mode

The 93PM Series UPS offers an Energy Saver System (ESS) mode that maximizes efficiency by eliminating unnecessary power conversion when the commercial power source is within acceptable voltage and frequency limits. In this mode, the UPS is actively monitoring the critical bus and instantly and seamlessly transitions to double-conversion mode (inverter online) if a commercial electrical power brownout, blackout, overvoltage, undervoltage, or out-of-tolerance frequency condition occurs. See Chapter 6, “UPS Operating Instructions,” for additional information.

1.1.5 Internal Redundancy

To deliver greater reliability, the Eaton 93PM UPS can be configured for internal redundancy. When configured, the UPS automatically becomes redundant if the load is at or below the capacity of the UPMs minus the capacity of one UPM. Under normal conditions the UPMs in the UPS share the load equally. If one or more UPMs becomes unavailable and the load is at or below the capacity of remaining UPMs, the remaining UPMs supply the load instead of transferring to bypass.

1.1.6 Advanced Battery Management

Advanced Battery Management (ABM) technology uses sophisticated sensing circuitry and a three-stage charger. The charger is a high-frequency, IGBT-based power conversion stage that extends the useful service life of UPS batteries by isolating the battery from the electrical environment, except for periodic charging or reserve mode operation. ABM also protects batteries from damage due to high current charging and inverter ripple currents. Charging at high currents can overheat and damage batteries.

ABM extends battery life by keeping the batteries charged and performing periodic battery testing. The battery test checks the batteries by transferring to battery mode. During the test the battery voltage is constantly monitored to determine Battery Health. ABM is intended for VRLA style batteries.

An ABM charging cycle starts with the charger driving the battery voltage at maximum current limit, to a battery charge level of 2.30 volts/cell. The time it takes for the voltage to reach to the battery charge level is saved as the battery charge time. If the battery charge time exceeds 24 hours, an alarm sounds.

When the battery reaches the float level, the battery is charged at the float level for 48 hours. Due to charger capability, some battery cabinet configurations extend float level to 72 hours. Twenty-four hours into the float period, a series of battery tests are performed to check the battery health. The float level charge continues after a successful test.

After initial startup, the battery run time on the front panel display indicates two minutes. After the 24-hour float charging period and automated battery testing, the actual battery run time is determined and the actual battery run time is displayed.

After the float period is completed, the charger is disconnected and the batteries are allowed to rest for 672 hours (28 days) maximum rest time. If the battery voltage falls below the opportunity charge level of 2.1V/cell during the first 240 hours (10 days) of the rest period, an alarm sounds.

An ABM charge cycle is initiated whenever one of these four conditions occurs since the last charge cycle:

- The batteries have rested over the maximum rest time of 672 hours.
- Accumulated discharge time is over a maximum battery discharge time of 20 seconds.
- Battery voltage is under the opportunity charge level of 2.1 volts/cell and the cabinet has been in rest mode for longer than 240 hours.
- A SHUT command or manual front display command Initiates Battery Test

1.2 Options and Accessories

Contact an Eaton sales representative for information about the following options.

1.2.1 Integrated Battery Cabinet

Battery backup protection with additional runtime can be provide by equipping the UPS system with up to four Integrated Battery Cabinets (IBCs) containing sealed lead-acid, maintenance-free batteries. The IBCs are housed in single, free-standing cabinets designed for line-up-and-match installation, but may be installed separate from the UPS cabinet. An external battery disconnect switch or tie point must be used when three or four IBCs are located separate from the UPS cabinet. The IBCs may be installed on either the right or left side of the UPS cabinet. The recommended installation location for adjacent battery cabinets is on the right side of the UPS cabinet.

1.2.2 Integrated Accessory Cabinet-Distribution

The Integrated Accessory Cabinet-Distribution (IAC-D) provides power distribution with up to 2 42-pole distribution panels or up to five 3-pole 100- 250A adjustable subfeed breakers. The IAC-D is housed in a single, free-standing cabinet designed for line-up-and-match installation, but may be installed separate from the UPS cabinet. The recommended installation location for an adjacent IAC-D is to the left of the UPS cabinet.

1.2.3 Sidecar Integrated Accessory Cabinet-Bypass

A Sidecar Integrated Accessory Cabinet-Bypass (SIAC-B) provides maintenance bypass functions. The SIAC-B is available in two, three, or four breaker configurations enabling power to completely bypass the UPS. The UPS can then be safely serviced or replaced without interrupting power to critical systems. The four breaker configuration provides a convenient method for removing power from the UPS when using the maintenance bypass to supply the load. The SIAC-B is housed in a cabinet attached to the UPS cabinet. The SIAC-B may be installed on either the right or left side of the UPS cabinet. The SIAC-B can also be used for top entry wiring access.

1.2.4 Sidecar Integrated Accessory Cabinet-Tie

A Sidecar Integrated Accessory Cabinet-Tie (SIAC-T) provides the ability to parallel up to four UPSs together for increased capacity and/or redundant capability. The SIAC-T is housed in a cabinet attached to the UPS cabinet. The SIAC-T may be installed on either the right or left side of the UPS cabinet. The SIAC-T can also be used for top entry wiring access.

1.2.5 Sidecar Integrated Accessory Cabinet-Tie Bypass

A Sidecar Integrated Accessory Cabinet-Tie Bypass (SIAC-TB) provides the ability to parallel two UPSs together for increased capacity and/or redundant capability. In addition, maintenance bypass functions enable power to completely bypass the UPS power module. The SIAC-TB is housed in a cabinet attached to the UPS cabinet. The SIAC-TB may be installed on either the right or left side of the UPS cabinet. The SIAC-TB can also be used for top entry wiring access.

1.2.6 Integrated Accessory Cabinet-Tie

An Integrated Accessory Cabinet-Tie (IAC-T) provides the ability to parallel up to four UPSs together for increased capacity and/or redundant capability. The IAC-T is housed in a single, free-standing cabinet designed for line-up-and-match installation, but may be installed separate from the UPS cabinet. The recommended installation location for an adjacent IAC-D is to the left of the UPS cabinet.

1.2.7 Parallel System



NOTE All UPSs in a parallel system must have the same battery configuration. Each UPS requires a separate battery cabinet.

A parallel UPS system with up to eight UPSs can be installed to provide a parallel capacity and/or redundant system. This load sharing system provides more capacity than a single UPS, and can provide backup, depending on the load and configuration. In addition, when one UPS is taken out of service for maintenance or is not operating properly, a redundant UPS continues to supply uninterrupted power to the critical load. A built-in Controller Area Network (CAN) provides connectivity for system metering and operational mode control. The parallel system consists of two to four UPSs each with a parallel CAN, and an IAC-T, SIAC-T, or SIAC-TB to act as a tie point and to control the output.

1.2.8 Top Entry Wiring Sidecar

If required, a sidecar is available for top entry power wiring. The sidecar performs the function of a wireway routing the wires to the terminals mounted at the bottom of the UPS cabinet. The sidecar can be installed on the left or right side of the UPS cabinet.

1.2.9 Monitoring and Communication

Minislot Cards – Optional Minislot cards support several protocols, such as SNMP, SMTP, HTTP, Modbus®, and TCP/IP.

See Chapter 7, “Communication,” for additional information on monitoring and communication features.

1.2.10 Additional Output Surge Protection

The Eaton 93PM UPS complies with ANSI 62.41 for line surges. However, if added security is required an additional Surge Protection Device (SPD) can be installed. For this application, a 480V Delta Style SPD Type 1 or Type 2 installed on the load side is recommended. The SPD must meet the Maximum Continuous Operating Voltage (MCOV) for a 480V Delta Style SPD. Eaton offers a variety of SPD solutions including the Eaton SPD Series with various kA ratings options.

1.3 Battery System

Although not provided with the UPS, a battery system is required to provide emergency short-term backup power to safeguard operation during brownouts, blackouts, and other power interruptions. The battery system should be equipped with lead-acid batteries. An external battery disconnect switch or tie point must be used when battery systems are located separate from the UPS cabinet and wiring exceeds the number of battery terminals available.

A supplemental 48 Vdc shunt trip signal for the battery disconnect device is provided by the UPS, but is not required for normal operation

1.4 Basic System Configurations

The following basic UPS system configurations are possible:

- Single UPS with one to four external battery cabinets
- Single UPS with one to four external battery cabinets and accessory cabinets
- Two to four UPSs with one to four external battery cabinets for each UPS
- Two to four UPSs with one to four external battery cabinets for each UPS and accessory cabinets

The UPS system configuration can be enhanced by adding optional accessories such as a Remote Emergency Power-off (REPO) control or Minislot communication cards.

1.5 Using This Manual

This manual describes how to install and operate the Eaton 93PM 20–100 kW. Read and understand the procedures described in this manual to ensure trouble-free installation and operation. In particular, be thoroughly familiar with the REPO procedure (see paragraph 6.3.16).

The information in this manual is divided into sections and chapters. The system, options, and accessories being installed dictate which parts of this manual should be read. At a minimum, Chapters 1 through 4 and Chapter 6 should be examined.

Read through each procedure before beginning the procedure. Perform only those procedures that apply to the UPS system being installed or operated.

1.6 Conventions Used in This Manual

This manual uses these type conventions:

- **Bold type** highlights important concepts in discussions, key terms in procedures, and menu options, or represents a command or option that you type or enter at a prompt.
- *Italic type* highlights notes and new terms where they are defined.
- `Screen type` represents information that appears on the screen or LCD.

Icon	Description
Note	Information notes call attention to important features or instructions.
[Keys]	Brackets are used when referring to a specific key, such as [Enter] or [Ctrl].

In this manual, the term UPS refers only to the UPS cabinet and its internal elements. The term UPS system refers to the entire power protection system – the UPS cabinet, an external battery system, and options or accessories installed.

The term line-up-and-match refers to accessory cabinets that are physically located adjacent to the UPS. The term standalone refers to accessory cabinets that are located separate from the UPS.

Left and right side notations are referenced standing in front of the cabinet.

1.7 Symbols, Controls, and Indicators

The following are examples of symbols used on the UPS or accessories to alert you to important information:



RISK OF ELECTRIC SHOCK - Observe the warning associated with the risk of electric shock symbol.



CAUTION: REFER TO OPERATOR'S MANUAL - Refer to your operator's manual for additional information, such as important operating and maintenance instructions.



This symbol indicates that you should not discard the UPS or the UPS batteries in the trash. This product contains sealed, lead-acid batteries and must be disposed of properly. For more information, contact your local recycling/reuse or hazardous waste center.



This symbol indicates that you should not discard waste electrical or electronic equipment (WEEE) in the trash. For proper disposal, contact your local recycling/reuse or hazardous waste center.

1.8 For More Information

Refer to the *Eaton 93PM Integrated Battery Cabinet Installation Manual – Large and Large High Rate* or the *Eaton 93PM Integrated Battery Cabinet Installation Manual-Small* for the following additional information:

- Installation instructions, including site preparation, planning for installation, wiring and safety information, and detailed illustrations of cabinets with dimensional and connection point drawings

Refer to the *Eaton 93PM Sidecar Integrated Accessory Cabinet-Bypass Installation and Operation (50 kW and 100 kW SIAC-B) Manual* for the following additional information:

- Installation instructions, including site preparation, planning for installation, wiring and safety information, and detailed illustrations of cabinets with dimensional and connection point drawings
- Operation, including breakers, standard features and optional accessories, procedures for using the bypass functions, and information about maintenance

Refer to the *Eaton 93PM Sidecar Integrated Accessory Cabinet-Tie and Tie Bypass (50 kW and 100 kW SIAC-T, and 50 kW and 100 kW SIAC-TB) Installation and Operation Manual* for the following additional information:

- Installation instructions, including site preparation, planning for installation, wiring and safety information, and detailed illustrations of cabinets with dimensional and connection point drawings
- Operation, including breakers, standard features and optional accessories, procedures for using the bypass functions, and information about maintenance

Refer to the *Eaton 93PM Integrated Accessory Cabinet-Tie (50 kW and 100 kW IAC-T) Installation and Operation Manual* for the following additional information:

- Installation instructions, including site preparation, planning for installation, wiring and safety information, and detailed illustrations of cabinets with dimensional and connection point drawings
- Operation, including breakers, standard features and optional accessories, procedures for using the bypass functions, and information about maintenance

Refer to the *Eaton 93PM Integrated Accessory Cabinet-Distribution (50 kW, 100 kW, 150 kW, and 200 kW IAC-D) Installation and Operation Manual* for the following additional information:

- Installation instructions, including site preparation, planning for installation, wiring and safety information, and detailed illustrations of cabinets with dimensional and connection point drawings
- Operation, including breakers, standard features and optional accessories, procedures for using the distribution functions, and information about maintenance

Visit www.eaton.com/powerquality or contact an Eaton service representative for information on how to obtain copies of these manuals.

1.9 Getting Help

If help is needed with any of the following:

- Scheduling initial startup
- Regional locations and telephone numbers
- A question about any of the information in this manual
- A question this manual does not answer

Please call the Customer Reliability Center at:

United States:	1-800-843-9433
Canada:	1-800-461-9166 ext 260
All other countries:	Call your local service representative

Please use the following e-mail address for manual comments, suggestions, or to report an error in this manual:

E-ESSDocumentation@eaton.com

This page intentionally left blank.

Chapter 2 Safety Warnings

IMPORTANT SAFETY INSTRUCTIONS SAVE THESE INSTRUCTIONS

This manual contains important instructions that should be followed during installation and maintenance of the UPS and batteries. Read all instructions before operating the equipment and save this manual for future reference.

The UPS is designed for industrial or computer room applications, and contains safety shields behind the door and front panels. However, the UPS is a sophisticated power system and should be handled with appropriate care.

DANGER

This UPS contains LETHAL VOLTAGES. All repairs and service should be performed by AUTHORIZED SERVICE PERSONNEL ONLY. There are NO USER SERVICEABLE PARTS inside the UPS.

WARNING

- The UPS is powered by its own energy source (batteries). The output terminals may carry live voltage even when the UPS is disconnected from an AC source.
 - To reduce the risk of fire or electric shock, install this UPS in a temperature and humidity controlled, indoor environment, free of conductive contaminants. Ambient temperature must not exceed 40°C (104°F). Do not operate near water or excessive humidity (95% maximum). The system is not intended for outdoor use.
 - As a result of the connected loads high leakage current is possible. Connection to earth ground is required for safety and proper product operation. Do not check UPS operation by any action that includes removal of the earth (ground) connection with loads attached.
 - Ensure all power is disconnected before performing installation or service.
 - Batteries can present a risk of electrical shock or burn from high short-circuit current. The following precautions should be observed: 1) Remove watches, rings, or other metal objects; 2) Use tools with insulated handles; 3) Do not lay tools or metal parts on top of batteries; 4) Wear rubber gloves and boots.
 - ELECTRIC ENERGY HAZARD. Do not attempt to alter any UPS or battery wiring or connectors. Attempting to alter wiring can cause injury.
 - Do not open or mutilate batteries. Released electrolyte is harmful to the skin and eyes. It may be toxic.
-

CAUTION

- Installation or servicing should be performed by qualified service personnel knowledgeable of UPS and battery systems, and required precautions. Keep unauthorized personnel away from equipment. Consider all warnings, cautions, and notes before installing or servicing equipment. DO NOT DISCONNECT the batteries while the UPS is in Battery mode.
- Replace batteries with the same number and type of batteries as originally installed with the UPS.
- Disconnect the charging source prior to connecting or disconnecting terminals.

- Determine if the battery is inadvertently grounded. If it is, remove the source of the ground. Contacting any part of a grounded battery can cause a risk of electric shock. An electric shock is less likely if you disconnect the grounding connection before you work on the batteries.
 - Proper disposal of batteries is required. Refer to local codes for disposal requirements.
 - Do not dispose of batteries in a fire. Batteries may explode when exposed to flame.
 - Keep the UPS door closed and front panels installed to ensure proper cooling airflow and to protect personnel from dangerous voltages inside the unit.
 - Do not install or operate the UPS system close to gas or electric heat sources.
 - Lead-acid batteries can present a risk of fire because they generate hydrogen gas. Do not smoke when near batteries. Do not cause flame or spark in battery area. Discharge static electricity from body before touching batteries by first touching a grounded metal surface.
 - The operating environment should be maintained within the parameters stated in this manual.
 - Keep surroundings uncluttered, clean, and free from excess moisture.
 - Observe all DANGER, CAUTION, and WARNING notices affixed to the inside and outside of the equipment.
-
-

 **AVERTISSEMENT!**

- Les batteries peuvent présenter un risque de décharge électrique ou de brûlure par des courts-circuits de haute intensité. Prendre les précautions nécessaires.
 - Pour le remplacement, utiliser le même nombre et modèle des batteries.
-
-

 **ATTENTION!**

- Une mise au rebut réglementaire des batteries est obligatoire. Consulter les règlements en vigueur dans votre localité.
 - Ne jamais jeter les batteries au feu. L'exposition aux flammes risque de les faire exploser.
 - Les accumulateurs au plomb-acide peuvent représenter un risque d'incendie, car ils génèrent de l'hydrogène gazeux. Ne pas fumer près des accumulateurs. Ne pas produire de flamme ou d'étincelle dans la zone de l'accumulateur. Dissiper l'électricité statique de votre corps en touchant une surface reliée à la terre avant de toucher les accumulateurs.
-
-

Section 1

Installation

Chapter 3 UPS Installation Plan and Unpacking

Use the following basic sequence of steps to install the UPS:

1. Create an installation plan for the UPS system (Chapter 3).
2. Prepare your site for the UPS system (Chapter 3).
3. Inspect and unpack the UPS cabinet (Chapter 3).
4. Unload and install the UPS cabinet, and wire the system (Chapter 4).
5. Install features, accessories, or options, as applicable (Chapter 4).
6. Complete the Installation Checklist (Chapter 4).
7. Have authorized service personnel perform preliminary operational checks and start up the system.

NOTE  Startup and operational checks must be performed by an authorized Eaton Customer Service Engineer, or the warranty terms specified on page W-1 become void. This service is offered as part of the sales contract for the UPS. Contact an Eaton service representative in advance (a minimum two-week notice is required) to reserve a preferred startup date.

3.1 Creating an Installation Plan

Before installing the UPS system, read and understand how this manual applies to the system being installed. Use the procedures and illustrations in paragraph 3.2 and Chapter 4 to create a logical plan for installing the system.

3.2 Preparing the Site

For the UPS system to operate at peak efficiency, the installation site should meet the environmental parameters outlined in this manual. The operating environment must meet the weight, clearance, and environmental requirements specified.

3.2.1 Environmental and Installation Considerations

The UPS system installation must meet the following guidelines:

- The system must be installed on a level floor suitable for computer or electronic equipment.
- The system must be operated at an altitude no higher than 1500m (5000 ft) without derating. For additional assistance with high altitude operation, contact an Eaton service representative (see paragraph 1.9).
- The system must be installed in a temperature and humidity controlled indoor area free of conductive contaminants.

Failure to follow guidelines may void your warranty.

The basic environmental requirements for operation of the UPS are:

- Ambient Temperature Range: 5–40°C (41–104°F)
- Recommended Operating Range: 5–40°C (41–104°F)
- Maximum Relative Humidity: 95%, noncondensing

 **CAUTION**

If battery systems are located in the same room as the UPS, the battery manufacturer's environmental requirements should be followed if they are more stringent than the UPS requirements. Operating temperatures above the recommended range will result in decreased battery life and performance, and may reduce or void the battery warranty.

The UPS ventilation requirements are shown in Table 3-1.

To allow for future power upgrades, Eaton recommends using air conditioning or ventilation sized for the fully rated UPS kW frame size installed instead of the derated kW ordered. Sizing the site cooling infrastructure to be capable of cooling the maximum kW frame size will allow a full power rating upgrade without having to modify the infrastructure.

Table 3-1. Air Conditioning or Ventilation Requirements During Full Load Operation

Model	UPS Rating	Input/Output Voltage	Heat Rejection BTU/hr x1000 (kg-cal/hr)	Minimum Required Cooling Air Flow
Eaton 93PM-100-1 Eaton 93PM-100-2 (N+1)	20 kW	480/480	2.55 (643)	378 liter/sec (800 cfm)
Eaton 93PM-100-1 Eaton 93PM-100-2 (N+1)	30 kW	480/480	3.58 (903)	
Eaton 93PM-100-1 Eaton 93PM-100-2 (N+1)	40 kW	480/480	4.56 (1150)	
Eaton 93PM-100-1 Eaton 93PM-100-2 (N+1)	50 kW	480/480	5.70 (1438)	
Eaton 93PM-100-2 Eaton 93PM-100-3 (N+1)	60 kW	480/480	7.16 (1807)	
Eaton 93PM-100-2 Eaton 93PM-100-3 (N+1)	70 kW	480/480	8.36 (2108)	
Eaton 93PM-100-2 Eaton 93PM-100-3 (N+1)	80 kW	480/480	9.12 (2300)	
Eaton 93PM-100-2 Eaton 93PM-100-3 (N+1)	90 kW	480/480	10.26 (2588)	
Eaton 93PM-100-2 Eaton 93PM-100-3 (N+1)	100 kW	480/480	11.40 (2875)	

The UPS equipment operating environment must meet the weight requirements shown in Table 3-2 and the size requirements shown in Figure 3-1 through Figure 3-8. Dimensions are in millimeters (inches).



NOTE Refer to the *Eaton 93PM Sidecar Integrated Accessory Cabinet-Tie and Tie Bypass (50 kW and 100 kW SIAC-T, and 50 kW and 100 kW SIAC-TB) Installation and Operation Manual* listed in paragraph 1.8 for Sidecar Integrated Accessory Cabinet-Tie and Sidecar Integrated Accessory Cabinet-Tie Bypass weight and size requirements.

Table 3-2. UPS Cabinet Weights

Model	Frame	Shipping	Weight kg (lb)	
			Installed	Point Loading
Eaton 93PM-100-1	Capacity	357 (786)	337 (743)	4 at 84 (186)
	Redundant	363 (799)	343 (756)	4 at 86 (189)
Eaton 93PM-100-2	Capacity	414 (912)	394 (869)	4 at 98 (217)
	Redundant	426 (939)	406 (896)	4 at 102 (224)
Eaton 93PM-100-3	Redundant	490 (1080)	470 (1037)	4 at 118 (259)
Eaton 93PM-100-1 with UPS Top Entry Wiring Sidecar (no breakers)	Capacity	429 (944)	406 (894)	4 at 102 (224)
	Redundant	434 (957)	411 (907)	4 at 103 (227)
Eaton 93PM-100-2 with UPS Top Entry Wiring Sidecar (no breakers)	Capacity	492 (1084)	469 (1034)	4 at 117 (259)
	Redundant	498 (1097)	475 (1047)	4 at 119 (262)
Eaton 93PM-100-3 with UPS Top Entry Wiring Sidecar (no breakers)	Redundant	562 (1238)	539 (1188)	4 at 135 (297)
Eaton 93PM-100-1 with four breaker Left-Mounted or Right-Mounted Sidecar Integrated Accessory Cabinet-Bypass (SIAC-B)	Capacity	457 (1005)	433 (954)	4 at 108 (239)
	Redundant	463 (1018)	439 (967)	4 at 110 (242)
Eaton 93PM-100-2 with four breaker Left-Mounted or Right-Mounted SIAC-B	Capacity	520 (1145)	496 (1094)	5 at 99 (219)
	Redundant	526 (1158)	502 (1107)	4 at 126 (277)
Eaton 93PM-100-3 with four breaker Left-Mounted or Right-Mounted SIAC-B	Redundant	590 (1299)	566 (1248)	4 at 142 (312)
UPS Top Entry Wiring Sidecar (no breakers)	—	—	74 (162)	—
Four breaker SIAC-B	—	—	106 (233)	—

The UPS cabinet uses forced air cooling to regulate internal component temperature. Air inlets are in the front of the cabinet and outlets are on top or in the back of the cabinet. Allow clearance in front of and on top or in back of the cabinet for proper air circulation. The clearances required around the UPS cabinet are shown in Table 3-3.

Table 3-3. UPS Cabinet Clearances

From Front of Cabinet	914.4 mm (36") working space
From Top of Cabinet with Top Exhaust (Zones 1 and 3 – see Figure 3-2)	457.2 mm (18") minimum clearance for ventilation
From Top of Cabinet (Zones 2 and 3– see Figure 3-2)	457.2 mm (18") working space
From Top of Cabinet with rear service access (Zone 2– see Figure 3-2)	Can be less than 457.2 mm (18")
From Back of Cabinet with Rear Exhaust	254 mm (10") minimum clearance for ventilation
From Back of Cabinet with Top Exhaust	None Required
From Back of Cabinet – Seismic Installation	914.4 mm (36") working space
From Right Side of Cabinet	None Required
From Left Side of Cabinet	None Required

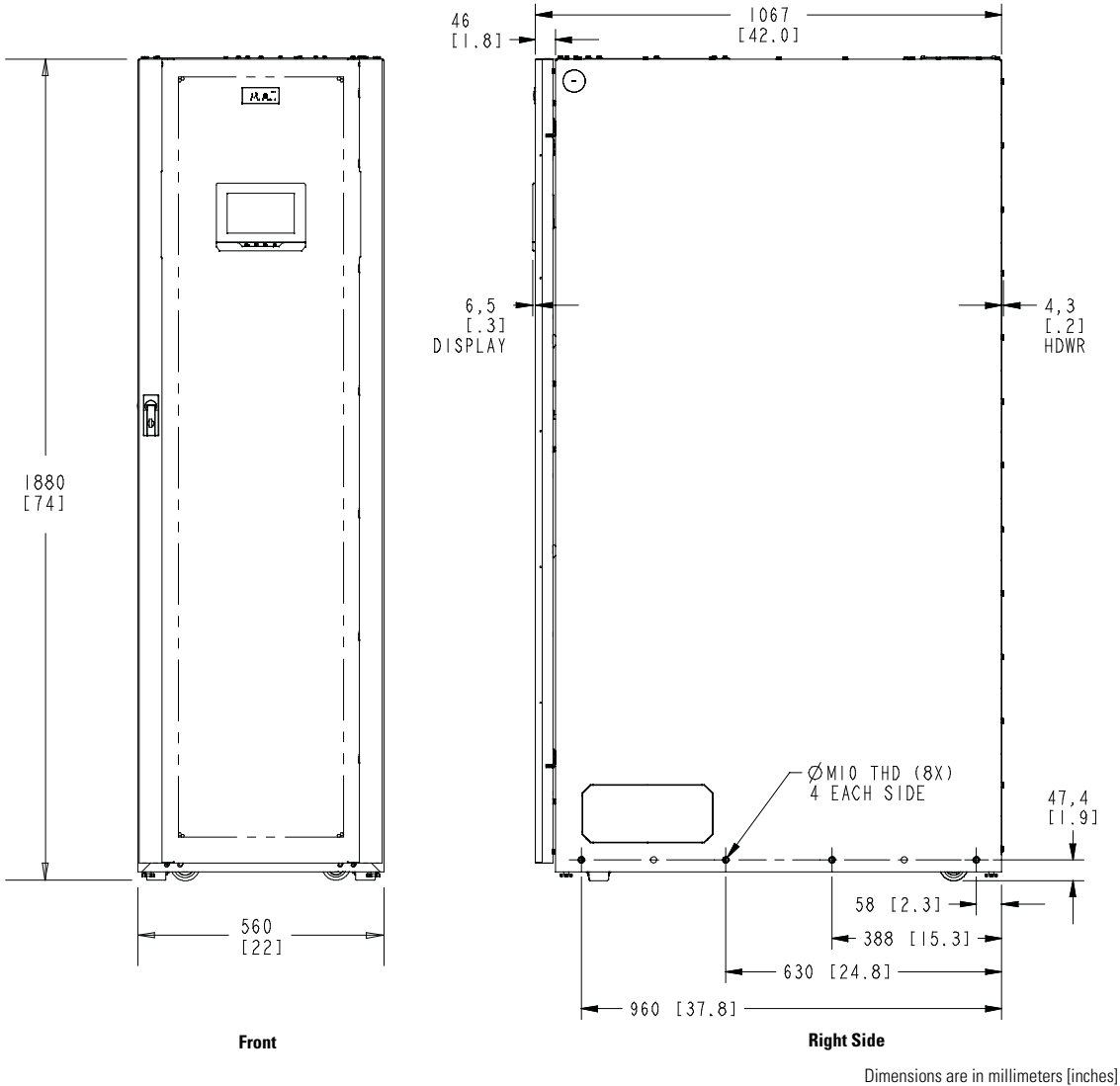
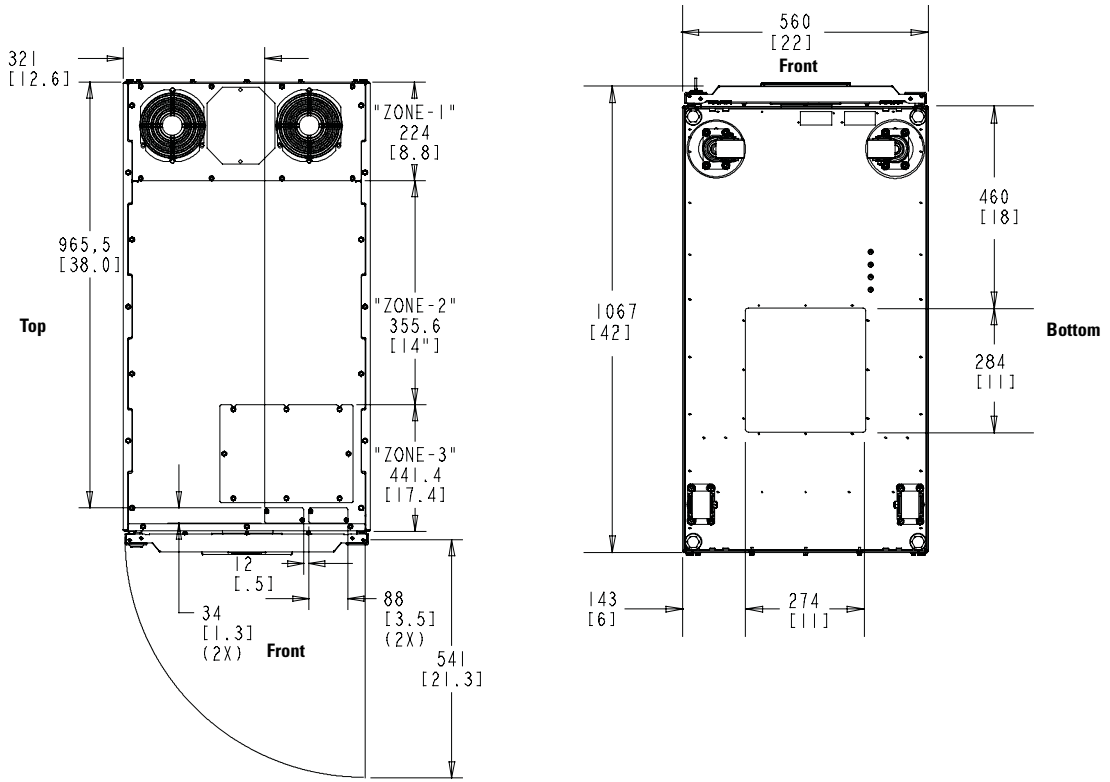

Figure 3-1. UPS Cabinet Dimensions (Front and Right Side Views)

UPS Installation Plan and Unpacking



NOTE Top exhaust configuration shown.

Dimensions are in millimeters [inches]

Figure 3-2. UPS Cabinet Dimensions (Top and Bottom Views)

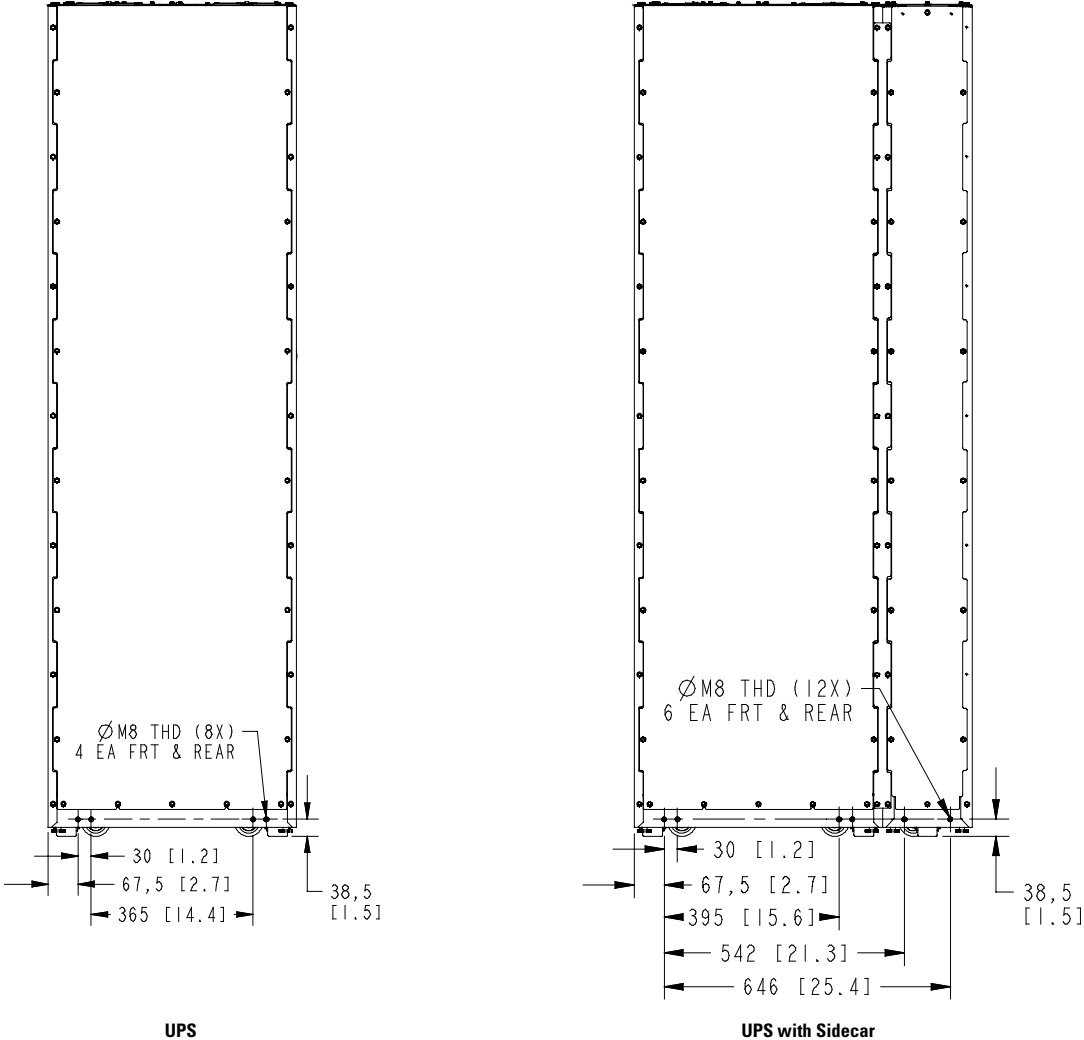
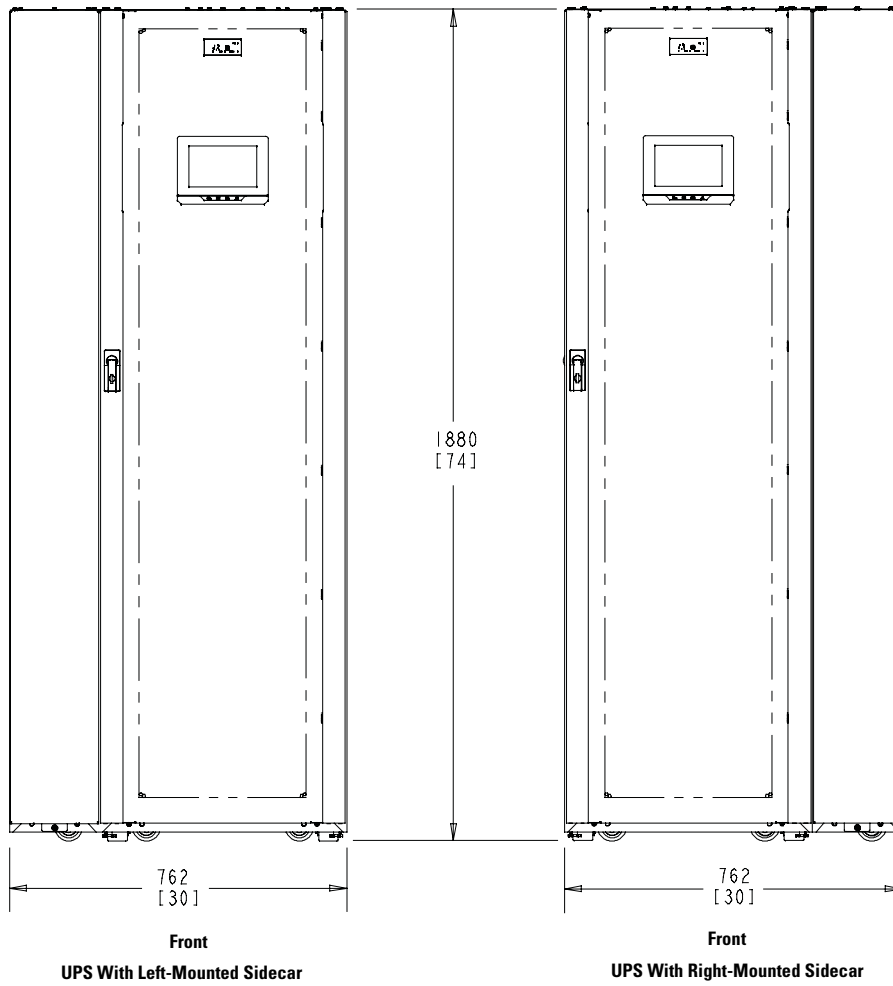
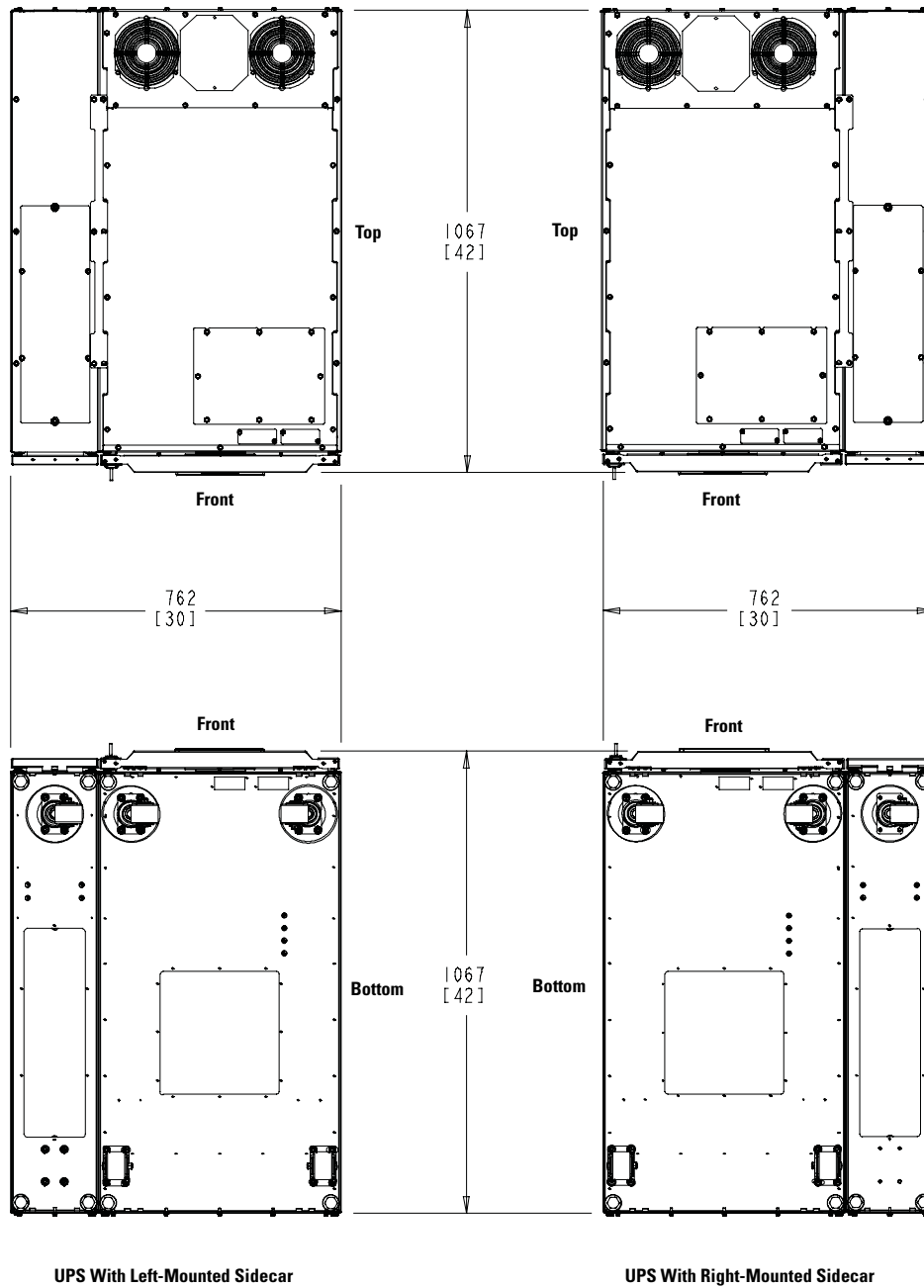

Figure 3-3. UPS Cabinet Front and Back Floor Mounting Bracket Mounting Dimensions (Back Views)



Dimensions are in millimeters [inches]

Figure 3-4. UPS Cabinet with Left-Mounted or Right-Mounted Sidecar Dimensions (Front and Right Side Views)



Dimensions are in millimeters [inches]

Figure 3-5. UPS Cabinet with Left-Mounted or Right-Mounted Sidecar Dimensions (Top and Bottom Views)

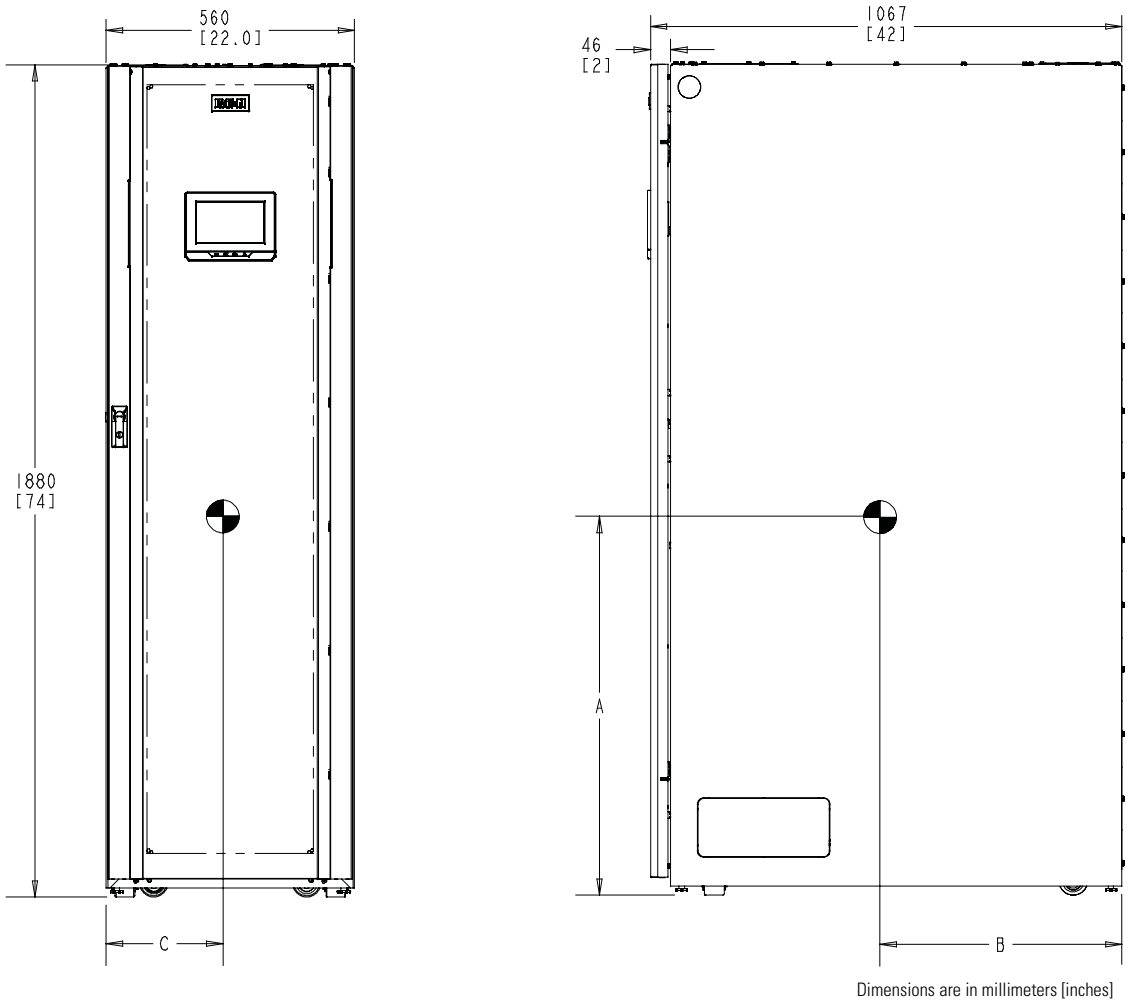

Weight and Center of Gravity					
	Frame	A mm (in)	B mm (in)	C mm (in)	Weight kg (lb)
Eaton 93PM-100-1 UPS	Capacity	842 (33.1)	537 (21.1)	276 (10.8)	337 (743)
	Redundant	845 (33.3)	537 (21.1)	276 (10.8)	343 (756)
Eaton 93PM-100-2 UPS	Capacity	921 (36.3)	537 (21.1)	276 (10.8)	394 (869)
	Redundant	922 (36.3)	537 (21.1)	276 (10.8)	406 (896)
Eaton 93PM-100-3 UPS	Redundant	1022 (40.2)	537 (21.1)	276 (10.8)	470 (1037)

Figure 3-6. UPS Cabinet Center of Gravity

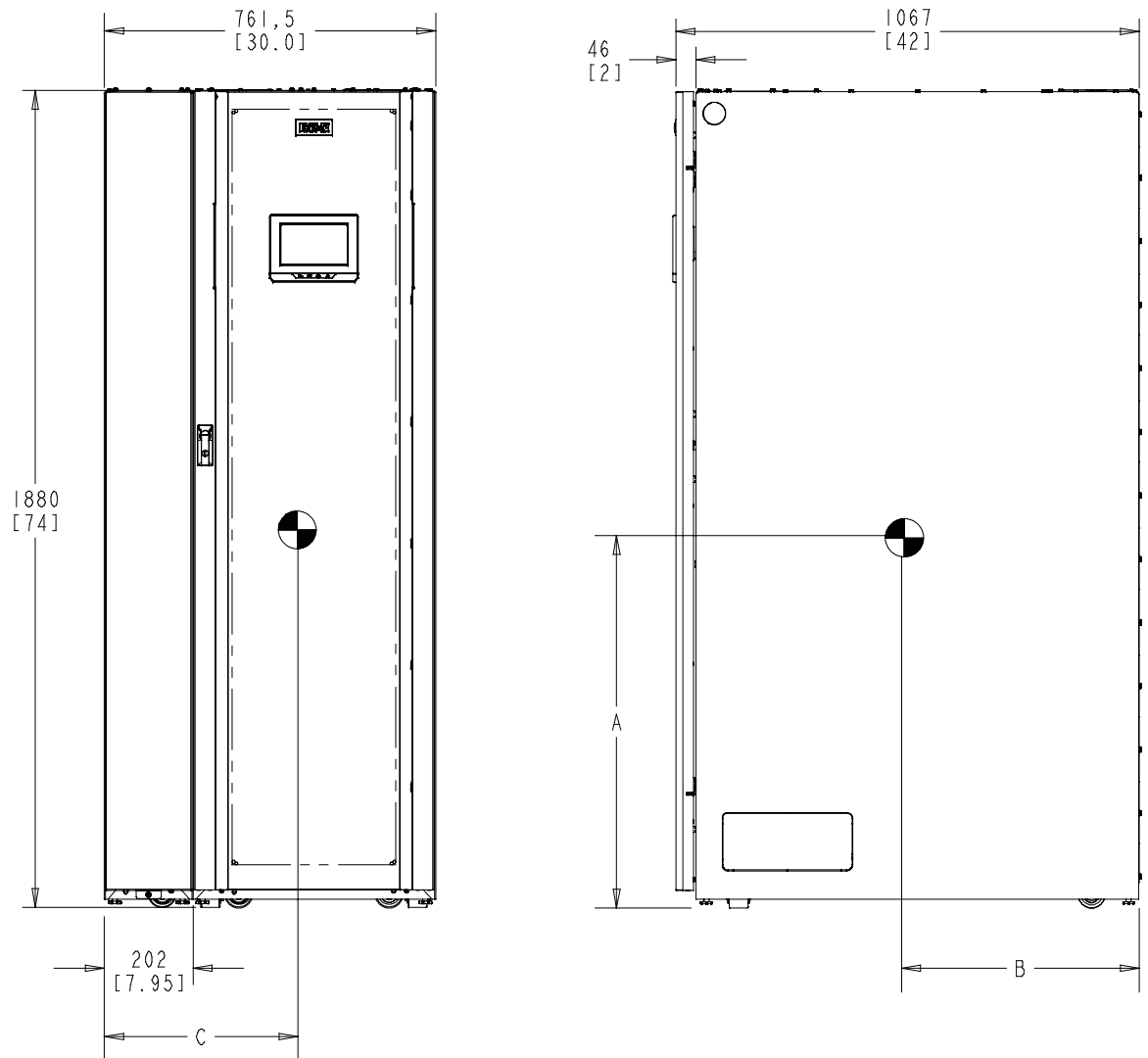

Dimensions are in millimeters [inches]

Figure 3-7. UPS Cabinet with Left-Mounted or Right-Mounted Sidecar Center of Gravity

UPS Installation Plan and Unpacking

Weight and Center of Gravity with Left-Mounted Sidecar (letters A, B, and C map to Figure 3-7)					
	Frame	A mm (in)	B mm (in)	C mm (in)	Weight kg (lb)
Eaton 93PM-100-1 UPS with UPS Top Entry Wiring Sidecar (no breakers)	Capacity	844 (33.2)	542 (21.3)	409 (16.1)	406 (894)
	Redundant	847 (33.3)	542 (21.3)	410 (16.1)	411 (907)
Eaton 93PM-100-2 UPS with UPS Top Entry Wiring Sidecar (no breakers)	Capacity	911 (35.8)	541 (21.3)	419 (16.5)	469 (1034)
	Redundant	913 (35.9)	541 (21.3)	420 (16.5)	475 (1047)
Eaton 93PM-100-3 UPS with UPS Top Entry Wiring Sidecar (no breakers)	Redundant	1001 (39.4)	541 (21.3)	427 (16.8)	539 (1188)
Eaton 93PM-100-1 UPS with four breaker SIAC-B	Capacity	855 (33.7)	568 (22.4)	390 (15.4)	433 (954)
	Redundant	858 (33.8)	568 (22.4)	391 (15.4)	439 (967)
Eaton 93PM-100-2 UPS with four breaker SIAC-B	Capacity	917 (36.1)	564 (22.2)	402 (15.8)	496 (1094)
	Redundant	918 (36.1)	564 (22.2)	403 (15.9)	502 (1107)
Eaton 93PM-100-3 with four breaker SIAC-B	Redundant	1001 (39.4)	561 (22.1)	412 (16.2)	566 (1248)

Weight and Center of Gravity with Right-Mounted Sidecar (letters A, B, and C map to Figure 3-7)					
	Frame	A mm (in)	B mm (in)	C mm (in)	Weight kg (lb)
Eaton 93PM-100-1 UPS with UPS Top Entry Wiring Sidecar (no breakers)	Capacity	844 (33.2)	542 (21.3)	347 (13.7)	406 (894)
	Redundant	847 (33.3)	542 (21.3)	346 (13.6)	411 (907)
Eaton 93PM-100-2 UPS with UPS Top Entry Wiring Sidecar (no breakers)	Capacity	911 (35.8)	541 (21.3)	338 (13.3)	469 (1034)
	Redundant	913 (35.9)	541 (21.3)	337 (13.3)	475 (1047)
Eaton 93PM-100-3 UPS with UPS Top Entry Wiring Sidecar (no breakers)	Redundant	1001 (39.4)	541 (21.3)	330 (13.0)	539 (1188)
Eaton 93PM-100-1 UPS with four breaker SIAC-B	Capacity	855 (33.7)	568 (22.4)	367 (14.4)	433 (954)
	Redundant	858 (33.8)	568 (22.4)	366 (14.4)	439 (967)
Eaton 93PM-100-2 UPS with four breaker SIAC-B	Capacity	917 (36.1)	564 (22.2)	356 (14.0)	496 (1094)
	Redundant	918 (36.1)	564 (22.2)	355 (14.0)	502 (1107)
Eaton 93PM-100-3 with four breaker SIAC-B	Redundant	1001 (39.4)	561 (22.1)	346 (13.6)	566 (1248)

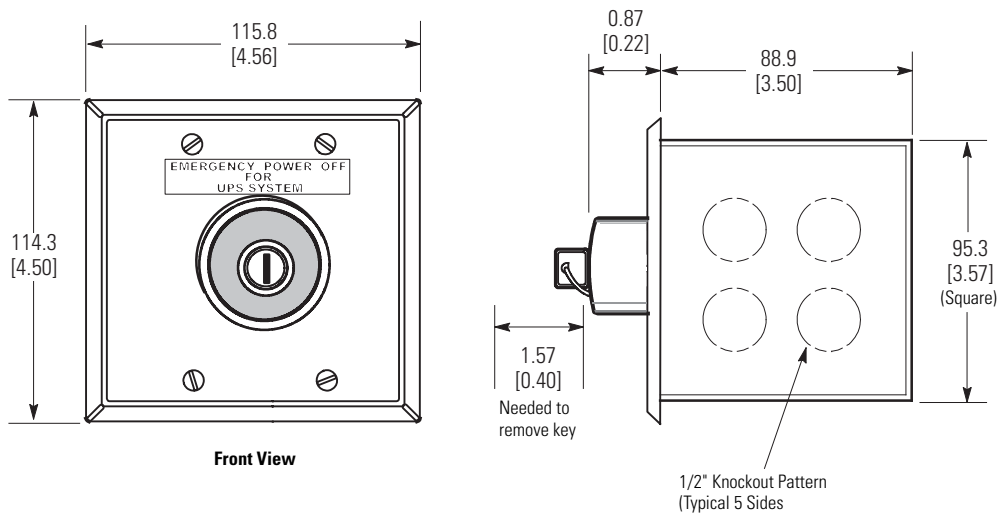

Dimensions are in millimeters [inches]

Figure 3-8. Remote EPO Switch Dimensions

3.2.2 UPS System Power Wiring Preparation



NOTE Refer to the *Eaton 93PM Sidecar Integrated Accessory Cabinet-Tie and Tie Bypass (50 kW and 100 kW SIAC-T, and 50 kW and 100 kW SIAC-TB) Installation and Operation Manual* listed in paragraph 1.8 for Sidecar Integrated Accessory Cabinet-Tie and Sidecar Integrated Accessory Cabinet-Tie Bypass power wiring preparation and requirements.

Read and understand the following notes while planning and performing the installation:

WARNING

As a result of the connected loads high leakage current is possible. Connection to earth ground is required for safety and proper product operation. Do not check UPS operation by any action that includes removal of the earth (ground) connection with loads attached.

- Refer to national and local electrical codes for acceptable external wiring practices.
- To allow for future power upgrades, Eaton recommends installing the UPS using wiring and external overcurrent protection breakers sized for the fully rated UPS kW frame size installed instead of the derated kW ordered. Wiring for the maximum kW frame size will allow a full power rating upgrade without having to modify the site wiring infrastructure.
- For external wiring, use 75°C copper wire. Wire sizes listed in Table 3-4 and Table 3-5 are for copper wiring only. If wire is run in an ambient temperature greater than 40°C, larger size wire may be necessary. Wire sizes are based on using the specified breakers.
- The AC output and output ground wiring to the critical load should be sized the same as the UPS rectifier, bypass, and rectifier and bypass ground wiring if the recommended output breaker listed in Table 3-10 is not installed in the system.
- Recommended wire sizes are based on NFPA National Electrical Code® (NEC®) 70 Table 310.15(B)(16) 75°C ampacity with 40°C ambient correction factors.
- Connect to a 3 wire, grounded Wye source or in single source applications, a 3-wire High Resistance Ground (HRG) source. A neutral conductor is not used from the source or supplied to the load.
- Supported single source, single or dual feed power sources
 - 3-wire grounded Wye (TN, TT)
 - 3-wire High Resistance Ground (IT)
- Supported dual source, dual feed power sources
 - 3-wire grounded Wye (TN, TT)

CAUTION

SINGLE HIGH IMPEDANCE GROUND SOURCE – In North American installations, the neutral conductor from the high impedance ground source of supply CANNOT be used.

- Phase rotation must be clockwise starting with phase A (rotation A,B,C).
- Material and labor for external wiring requirements are to be supplied by designated personnel.

- The bypass feed into this equipment uses three wires. The rectifier feed into this equipment uses three wires. The phases must be symmetrical about ground (from a Wye source, phase rotation clockwise A, B, C) for proper equipment operation.
- If installing an external maintenance bypass, all feeds to the UPS including the Rectifier Input Breaker (RIB) (if installed) must have a service disconnect independent of the maintenance bypass power path. Most maintenance bypass solutions provide UPS input feeds derived from but isolated from the maintenance bypass power path. If the maintenance bypass solution being installed does not provide such functionality, DO NOT use a single feeder breaker to supply both the UPS and the maintenance bypass.

3.2.3 External Parallel UPS System Power Wiring Preparation

Read and understand the following notes in addition to the notes in paragraph 3.2.2 while planning and performing the external parallel installation:

- All external parallel UPS rectifier inputs must come from one source and all bypass input feeds must come from one source.
- All UPSs in the external parallel system must contain the same number of UPMs. Mixed UPS kVA ratings are not permitted.
- External parallel UPS input wiring size requirements and output wiring size requirements from the UPSs to the tie cabinet are the same as listed in Table 3-4, or Table 3-5.
- The tie cabinet must contain Module Output Breakers (MOBs) with dual auxiliary contacts for control of the system. Without dual auxiliary MOBs, UPMs are not allowed to go to bypass individually during servicing. All UPMs will go to bypass instead of just the UPM needing service, decreasing critical load protection. With dual auxiliary MOBs, one UPM can be bypassed while the remaining UPMs support the load as long as the remaining UPMs have the capacity to do so.
- External parallel system wiring length should be in accordance with Figure 3-9, to ensure approximately equal current sharing when in bypass mode.

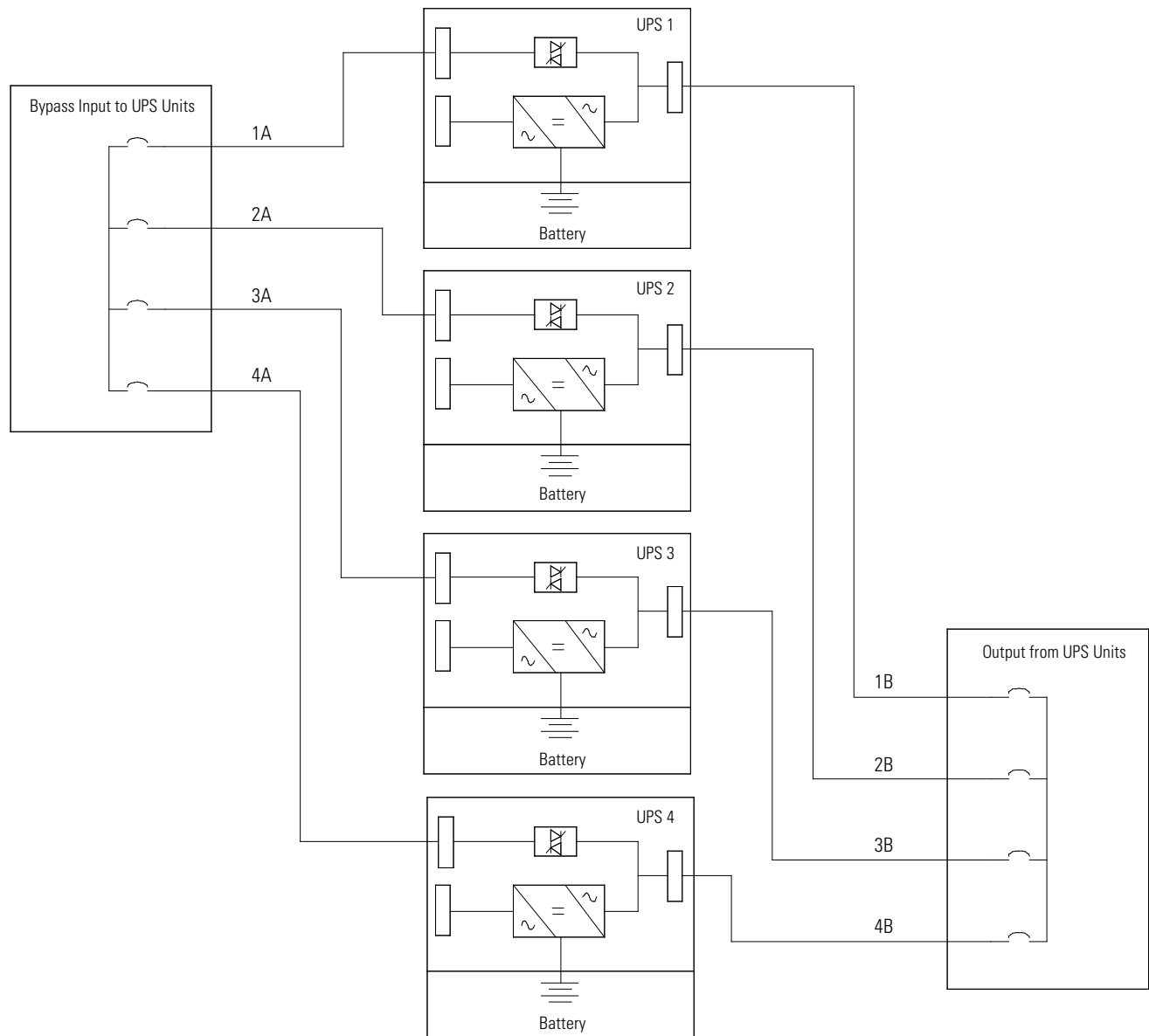

NOTE Required parallel system wiring length must be equal to ensure approximately equal current sharing when in Bypass mode. For proper operation the following must be true:

$$1A = 2A = 3A = 4A$$

$$1B = 2B = 3B = 4B$$

NOTE Any difference in wire length will result in decreased capacity of the UPS system while on bypass. For example, a 10% difference between the longest and shortest wire lengths will result in a decrease in bypass capacity of 10%.

Figure 3-9. 93PM External Parallel Wire Length

UPS Installation Plan and Unpacking

For external wiring requirements, including the minimum AWG size of external wiring, see Table 3-4 or Table 3-5. Wire sizes listed are for copper wiring only.

Table 3-4. Input/Output Ratings and External Wiring Requirements for the Eaton 93PM-100-1 and 93PM-100-2 (N+1)

Basic Unit Rating	Units	Rating 50/60 Hz				
	kW	20	30	40	50	
Input and Output Voltage	Volts	480/480	480/480	480/480	480/480	
AC Input to UPS Rectifier (0.99 Minimum pF)	Amps	35	48	60	73	
Full load current plus battery recharge current (3) Phases, (1) Ground	A					
Minimum Conductor Size (Phase A, B, and C) Number per Phase		AWG or kcmil (each)	8 (1)	4 (1)	3 (1)	2 (1)
Minimum Conductor Size (Ground) Number	—	AWG or kcmil (each)	10 (1)	8 (1)	8 (1)	8 (1)
AC Input to UPS Bypass (Three Wire, Dual-Feed)	Amps	35	48	60	73	
Full Load Current (3) Phases, (1) Ground	B					
Minimum Conductor Size (Phase A, B, and C) Number per Phase		AWG or kcmil (each)	8 (1)	4 (1)	3 (1)	2 (1)
Minimum Conductor Size (Ground) Number	—	AWG or kcmil (each)	10 (1)	8 (1)	8 (1)	8 (1)
DC Input from External Battery (Line-Up-and-Match Eaton 93PM IBC)	Total Amps (216 cell)	50	74	99	124	
(1) Positive, (1) Negative, (1) Ground	Total Amps (240 cell)	45	67	89	111	
Minimum Conductor Size (Phase Positive and Negative) Number per Pole	C	AWG or kcmil (each)	2/0 (1)	2/0 (1)	2/0 (1)	2/0 (1)
Minimum Conductor Size (Ground) Number		—	AWG or kcmil (each)	4 (1)	4 (1)	4 (1)
DC Input from External Battery (Standalone Eaton 93PM IBC)	Total Amps (216 cell)	50	74	99	124	
(1) Positive, (1) Negative, (1) Ground	Total Amps (240 cell)	45	67	89	111	
Minimum Conductor Size (Phase Positive and Negative) Number per Pole	C	AWG or kcmil (each)	3/0 (2)	3/0 (2)	3/0 (2)	3/0 (2)
Minimum Conductor Size (Ground) Number		—	AWG or kcmil (each)	4 (1)	4 (1)	4 (1)
AC Output to Critical Load (Three Wire)	Amps	24	36	48	60	
Full Load Current (3) Phases, (1) Ground	D					
Minimum Conductor Size (Phase A, B, and C) Number per Phase		AWG or kcmil (each)	8 (1)	6 (1)	4 (1)	3 (1)
Minimum Conductor Size (Ground) Number	—	AWG or kcmil (each)	10 (1)	10 (1)	8 (1)	8 (1)

NOTE Callout letters **A**, **B**, **C** and **D** map to Figure 5-6 through Figure 5-13.

NOTE Line-up-and-match battery wiring with a 105°C rating is factory supplied with the Eaton 93PM Integrated Battery Cabinet (IBC).

Table 3-5. Input/Output Ratings and External Wiring Requirements for the Eaton 93PM-100-2 and 93PM-100-3 (N+1)

Basic Unit Rating	Units		Rating 50/60 Hz				
	kW		60	70	80	90	100
Input and Output Voltage	Volts		480/480	480/480	480/480	480/480	480/480
AC Input to UPS Rectifier (0.99 Minimum pF)	Amps		94	108	120	133	146
Full load current plus battery recharge current (3) Phases, (1) Ground	A						
Minimum Conductor Size (Phase A, B, and C) Number per Phase		AWG or kcmil (each)	1/0 (1)	2/0 (1)	2/0 (1)	3/0 (1)	4/0 (1)
Minimum Conductor Size (Ground) Number		— AWG or kcmil (each)	6 (1)	6 (1)	6 (1)	6 (1)	6 (1)
AC Input to UPS Bypass (Three Wire, Dual-Feed)	Amps		94	108	120	133	146
Full Load Current (3) Phases, (1) Ground	B						
Minimum Conductor Size (Phase A, B, and C) Number per Phase		AWG or kcmil (each)	1/0 (1)	2/0 (1)	2/0 (1)	3/0 (1)	4/0 (1)
Minimum Conductor Size (Ground) Number		— AWG or kcmil (each)	6 (1)	6 (1)	6 (1)	6 (1)	6 (1)
DC Input from External Battery (Line-Up-and-Match Eaton 93PM IBC)	Total Amps (216 cell)		149	174	198	223	247
(1) Positive, (1) Negative, (1) Ground	C	Total Amps (240 cell)	134	156	178	200	223
Minimum Conductor Size (Phase Positive and Negative) Number per Pole		AWG or kcmil (each)	2/0 (1)	2/0 (1)	2/0 (1)	2/0 (1)	2/0 (1)
Minimum Conductor Size (Ground) Number		— AWG or kcmil (each)	4 (1)	4 (1)	4 (1)	4 (1)	4 (1)
		See Note	See Note	See Note	See Note	See Note	
DC Input from External Battery (Standalone Eaton 93PM IBC)	Total Amps (216 cell)		149	174	198	223	247
(1) Positive, (1) Negative, (1) Ground	C	Total Amps (240 cell)	134	156	178	200	223
Minimum Conductor Size (Phase Positive and Negative) Number per Pole		AWG or kcmil (each)	3/0 (2)	3/0 (2)	3/0 (2)	3/0 (2)	3/0 (2)
Minimum Conductor Size (Ground) Number		— AWG or kcmil (each)	4 (1)	4 (1)	4 (1)	4 (1)	4 (1)
AC Output to Critical Load (Three Wire)	Amps		72	84	96	108	120
Full Load Current (3) Phases, (1) Ground	D						
Minimum Conductor Size (Phase A, B, and C) Number per Phase		AWG or kcmil (each)	2 (1)	1 (1)	1/0 (1)	2/0 (1)	2/0 (1)
Minimum Conductor Size (Ground) Number		— AWG or kcmil (each)	6 (1)	6 (1)	6 (1)	6 (1)	6 (1)

NOTE Callout letters **A**, **B**, **C** and **D** map to Figure 5-10 through Figure 5-17.

NOTE Line-up-and-match battery wiring with a 105°C rating is factory supplied with the Eaton 93PM Integrated Battery Cabinet (IBC).

UPS Installation Plan and Unpacking

The power wiring terminals are pressure terminations, UL and CSA rated. See Table 3-6 for external power cable terminations.

Figure 4-7 and Figure 4-8 show the location of the UPS power cable terminals.

Table 3-6. UPS External Power Cable Terminations for the Eaton 93PM-100-1, 93PM-100-2, and 93PM-100-3

Terminal Function	Terminal	Function	Number and Size of Pressure Termination AWG or kcmil	Tightening Torque Nm (lb in)	Screw Size and Type
AC Input to UPS Rectifier	E1	Phase A	2 - #6-250 kcmil	22.6 (200)	1/4" Hex
	E2	Phase B	2 - #6-250 kcmil	22.6 (200)	1/4" Hex
	E3	Phase C	2 - #6-250 kcmil	22.6 (200)	1/4" Hex
AC Input to Bypass	E6	Phase A	2 - #6-250 kcmil	22.6 (200)	1/4" Hex
	E7	Phase B	2 - #6-250 kcmil	22.6 (200)	1/4" Hex
	E8	Phase C	2 - #6-250 kcmil	22.6 (200)	1/4" Hex
AC Output to Critical Load	E9	Phase A	2 - #6-250 kcmil	22.6 (200)	1/4" Hex
	E10	Phase B	2 - #6-250 kcmil	22.6 (200)	1/4" Hex
	E11	Phase C	2 - #6-250 kcmil	22.6 (200)	1/4" Hex
DC Input from Battery	E4	Battery (+)	4 - #6-250 kcmil	22.6 (200)	1/4" Hex
	E5	Battery (-)	4 - #6-250 kcmil	22.6 (200)	1/4" Hex
Customer Ground	Ground	Ground	6 - #14-1/0	5.1 (45)	Slotted

NOTE Customer ground, sized in accordance with NEC Table 250.122, can be run in any conduit listed in Table 3-7 or Table 3-8.

Conduit sizes were chosen from NEC Table 4, Electrical Metallic Tubing (EMT). See Table 3-7 or Table 3-8 for conduit requirements.

Per NEC article 300, 3(B), all three-phase conductors must be run in the same conduit. A ground wire must be run in the same conduit as the phase conductors.

When running parallel wires in multiple conduits a ground wire must be run in each conduit in accordance with NEC Table 250.122.

Conduit is sized to accommodate one ground conductor per conduit, sized in accordance with NEC Table 250.122.

Conduit sizes listed are for copper wiring only.

Table 3-7. Power Cable Conduit Requirements for the Eaton 93PM-100-1 and Eaton 93PM-100-2 (N+1)

UPS Model	UPS Rating	Voltage	Terminal	Number of Wires in Conduit	Minimum Conduit Trade Size	Number of Conduits
Eaton 93PM-100-1 Eaton 93PM-100-2 (N+1)	20 kW	480 Vac	AC Input to UPS Rectifier and Bypass (A, B, C, Ground)	4	3/4	1
			AC Output (Three Wire) (A, B, C, Ground)	4	3/4	1
		DC	Battery (Positive, Negative, Ground)	5	2-1/2	1
Eaton 93PM-100-1 Eaton 93PM-100-2 (N+1)	30 kW	480 Vac	AC Input to UPS Rectifier and Bypass (A, B, C, Ground)	4	1-1/4	1
			AC Output (Three Wire) (A, B, C, Ground)	4	1	1
		DC	Battery (Positive, Negative, Ground)	5	2-1/2	1
Eaton 93PM-100-1 Eaton 93PM-100-2 (N+1)	40 kW	480 Vac	AC Input to UPS Rectifier and Bypass (A, B, C, Ground)	4	1-1/4	1
			AC Output (Three Wire) (A, B, C, Ground)	4	1-1/4	1
		DC	Battery (Positive, Negative, Ground)	5	2-1/2	1
Eaton 93PM-100-1 Eaton 93PM-100-2 (N+1)	50 kW	480 Vac	AC Input to UPS Rectifier and Bypass (A, B, C, Ground)	4	1-1/4	1
			AC Output (Three Wire) (A, B, C, Ground)	4	1-1/4	1
		DC	Battery (Positive, Negative, Ground)	5	2-1/2	1

NOTE Wires per conduit include ground wire.

UPS Installation Plan and Unpacking

Table 3-8. Power Cable Conduit Requirements for the Eaton 93PM-100-2 and Eaton 93PM-100-3 (N+1)

UPS Model	UPS Rating	Voltage	Terminal	Number of Wires in Conduit	Minimum Conduit Trade Size	Number of Conduits
Eaton 93PM-100-2 Eaton 93PM-100-3 (N+1)	60 kW	480 Vac	AC Input to UPS Rectifier and Bypass (A, B, C, Ground)	4	1-1/2	1
			AC Output (Three Wire) (A, B, C, Ground)	4	1-1/4	1
		DC	Battery (Positive, Negative, Ground)	5	2-1/2	1
Eaton 93PM-100-2 Eaton 93PM-100-3 (N+1)	70 kW	480 Vac	AC Input to UPS Rectifier and Bypass (A, B, C, Ground)	4	2	1
			AC Output (Three Wire) (A, B, C, Ground)	4	1-1/2	1
		DC	Battery (Positive, Negative, Ground)	5	2-1/2	1
Eaton 93PM-100-2 Eaton 93PM-100-3 (N+1)	80 kW	480 Vac	AC Input to UPS Rectifier and Bypass (A, B, C, Ground)	4	2	1
			AC Output (Three Wire) (A, B, C, Ground)	4	1-1/2	1
		DC	Battery (Positive, Negative, Ground)	5	2-1/2	1
Eaton 93PM-100-2 Eaton 93PM-100-3 (N+1)	90 kW	480 Vac	AC Input to UPS Rectifier and Bypass (A, B, C, Ground)	4	2	1
			AC Output (Three Wire) (A, B, C, Ground)	4	2	1
		DC	Battery (Positive, Negative, Ground)	5	2-1/2	1
Eaton 93PM-100-2 Eaton 93PM-100-3 (N+1)	100 kW	480 Vac	AC Input to UPS Rectifier and Bypass (A, B, C, Ground)	4	2	1
			AC Output (Three Wire) (A, B, C, Ground)	4	2	1
		DC	Battery (Positive, Negative, Ground)	5	2-1/2	1

NOTE Wires per conduit include ground wire.

External overcurrent protection and disconnect are not provided by this product, but are required by codes. Refer to Table 3-4 or Table 3-5 for wiring requirements. If an output lockable disconnect is required, it is to be supplied by the customer.

Table 3-9 lists the recommended rating for input and bypass circuit breakers.

Table 3-9. Recommended Input and Bypass Circuit Breaker Ratings

UPS Model	UPS Rating	Input Rating	
		Load Rating	480V
Eaton 93PM-100-1	20 kW	80% Rated	45A
Eaton 93PM-100-2 (N+1)		100% Rated	40A
Eaton 93PM-100-1	30 kW	80% Rated	70A
Eaton 93PM-100-2 (N+1)		100% Rated	50A
Eaton 93PM-100-1	40 kW	80% Rated	80A
Eaton 93PM-100-2 (N+1)		100% Rated	70A
Eaton 93PM-100-1	50 kW	80% Rated	100A
Eaton 93PM-100-2 (N+1)		100% Rated	80A
Eaton 93PM-100-2	60 kW	80% Rated	150A
Eaton 93PM-100-3 (N+1)		100% Rated	110A
Eaton 93PM-100-2	70 kW	80% Rated	150A
Eaton 93PM-100-3 (N+1)		100% Rated	125A
Eaton 93PM-100-2	80 kW	80% Rated	175A
Eaton 93PM-100-3 (N+1)		100% Rated	150A
Eaton 93PM-100-2	90 kW	80% Rated	200A
Eaton 93PM-100-3 (N+1)		100% Rated	150A
Eaton 93PM-100-2	100 kW	80% Rated	200A
Eaton 93PM-100-3 (N+1)		100% Rated	175A

 **CAUTION**

To reduce the risk of fire, connect only to a circuit provided with maximum input circuit breaker current ratings from Table 3-9 in accordance with the NEC, ANSI/NFPA 70.

The line-to-line unbalanced output capability of the UPS is limited only by the full load per phase current values for AC output to critical load shown in Table 3-4 or Table 3-5. The recommended line-to-line load unbalance is 50% or less.

Bypass and output overcurrent protection and bypass and output disconnect switches are to be supplied by the customer. Table 3-10 lists the recommended rating for output circuit breakers.

Table 3-10. Recommended Output Circuit Breaker Ratings

UPS Model	UPS Rating	Output Rating	
		Load Rating	480V
Eaton 93PM-100-1	20 kW	80% Rated	35A
Eaton 93PM-100-2 (N+1)		100% Rated	25A
Eaton 93PM-100-1	30 kW	80% Rated	50A
Eaton 93PM-100-2 (N+1)		100% Rated	40A
Eaton 93PM-100-1	40 kW	80% Rated	70A
Eaton 93PM-100-2 (N+1)		100% Rated	50A
Eaton 93PM-100-1	50 kW	80% Rated	80A
Eaton 93PM-100-2 (N+1)		100% Rated	70A
Eaton 93PM-100-2	60 kW	80% Rated	100A
Eaton 93PM-100-3 (N+1)		100% Rated	80A
Eaton 93PM-100-2	70 kW	80% Rated	110A
Eaton 93PM-100-3 (N+1)		100% Rated	100A
Eaton 93PM-100-2	80 kW	80% Rated	125A
Eaton 93PM-100-3 (N+1)		100% Rated	100A
Eaton 93PM-100-2	90 kW	80% Rated	150A
Eaton 93PM-100-3 (N+1)		100% Rated	125A
Eaton 93PM-100-2	100 kW	80% Rated	150A
Eaton 93PM-100-3 (N+1)		100% Rated	125A

There is no manual DC disconnect device within the UPS.

Battery voltage is computed at 2 volts per cell as defined by Article 480 of the NEC. Rated battery current is computed based on 2 volts per cell.

External DC input overcurrent protection and disconnect switch is to be supplied by the customer. Table 3-11 and Table 3-12 list the maximum ratings for continuous-duty rated circuit breakers satisfying the criteria for both. Recommended disconnect size is based on a maximum full load discharge time less than 3 hours. For longer discharge times a larger disconnect may be required.

Table 3-11. Recommended DC Input Battery Disconnect Circuit Breaker Ratings (216 Cell)

UPS Model	UPS Rating	Output Rating	
			480V
Eaton 93PM-100-1 Eaton 93PM-100-2 (N+1)	20 kW	100% Rated	60A
Eaton 93PM-100-1 Eaton 93PM-100-2 (N+1)	30 kW	100% Rated	90A
Eaton 93PM-100-1 Eaton 93PM-100-2 (N+1)	40 kW	100% Rated	125A
Eaton 93PM-100-1 Eaton 93PM-100-2 (N+1)	50 kW	100% Rated	150A
Eaton 93PM-100-2 Eaton 93PM-100-3 (N+1)	60 kW	100% Rated	200A
Eaton 93PM-100-2 Eaton 93PM-100-3 (N+1)	70 kW	100% Rated	225A
Eaton 93PM-100-2 Eaton 93PM-100-3 (N+1)	80 kW	100% Rated	250A
Eaton 93PM-100-2 Eaton 93PM-100-3 (N+1)	90 kW	100% Rated	300A
Eaton 93PM-100-2 Eaton 93PM-100-3 (N+1)	100 kW	100% Rated	300A

Table 3-12. Recommended DC Input Battery Disconnect Circuit Breaker Ratings (240 Cell)

UPS Model	UPS Rating	Output Rating	
			480V
Eaton 93PM-100-1 Eaton 93PM-100-2 (N+1)	20 kW	100% Rated	60A
Eaton 93PM-100-1 Eaton 93PM-100-2 (N+1)	30 kW	100% Rated	90A
Eaton 93PM-100-1 Eaton 93PM-100-2 (N+1)	40 kW	100% Rated	125A
Eaton 93PM-100-1 Eaton 93PM-100-2 (N+1)	50 kW	100% Rated	150A
Eaton 93PM-100-2 Eaton 93PM-100-3 (N+1)	60 kW	100% Rated	175A
Eaton 93PM-100-2 Eaton 93PM-100-3 (N+1)	70 kW	100% Rated	200A
Eaton 93PM-100-2 Eaton 93PM-100-3 (N+1)	80 kW	100% Rated	225A
Eaton 93PM-100-2 Eaton 93PM-100-3 (N+1)	90 kW	100% Rated	250A
Eaton 93PM-100-2 Eaton 93PM-100-3 (N+1)	100 kW	100% Rated	300A

3.2.4 UPS System Interface Wiring Preparation

NOTE  Refer to the *Eaton 93PM Sidecar Integrated Accessory Cabinet-Tie and Tie Bypass (50 kW and 100 kW SIAC-T, and 50 kW and 100 kW SIAC-TB) Installation and Operation Manual* listed in paragraph 1.8 for Sidecar Integrated Accessory Cabinet-Tie and Sidecar Integrated Accessory Cabinet-Tie Bypass weight and size requirements.

Control wiring for features and options should be connected at the customer interface terminal blocks located inside the UPS.

 **WARNING**

Do not directly connect relay contacts to the mains related circuits. Reinforced insulation to the mains is required.

Read and understand the following notes while planning and performing the installation:

- Use Class 1 wiring methods (as defined by the NEC) for interface wiring from 30V to 600V. The wire should be rated for 600V, 1A minimum. 12 AWG maximum wire size.
- Use Class 2 wiring methods (as defined by the NEC) for interface wiring up to 30V. The wire should be rated for 24V, 1A minimum.
- Because of the battery shunt trip wiring route in the UPS cabinet, the wire should be rated for a minimum of 600V.
- Use twisted-pair wires for each input and return or common.
- All interface wiring and conduit is to be supplied by the customer.
- When installing external interface wiring between a building alarm, relay output, battery breaker trip, or Minislot and the UPS interface terminals, conduit must be installed between each device and the UPS cabinet.
- If using conduit, install the interface wiring in separate conduit from the power wiring.
- All building alarm inputs require an isolated normally-open contact or switch (rated at 24 Vdc, 20 mA minimum) connected between the alarm input and common terminal. All control wiring and switch contacts are customer-supplied.
- LAN and telephone drops for use with Minislot connectivity cards must be supplied by the customer.
- The UPS battery detect signal wiring from an UPS building alarm must be connected to the battery disconnect device.
- Program the battery detect building alarm to read battery open and for normally open contacts.
- A supplemental 48 Vdc shunt trip signal for the battery disconnect device is provided, but is not required for normal operation.
- Battery detect and 48 Vdc shunt trip wiring should be a minimum of 18 AWG
- The REPO feature opens all switchgear in the UPS cabinet and isolates power from your critical load. Local electrical codes may also require tripping upstream protective devices to the UPS.
- The REPO switch must be a latching-type switch not tied to any other circuits.
- A jumper wire must be connected between pins 3 and 4 on the REPO terminal block if using a normally-closed REPO switch.
- REPO wiring should be a minimum of 18 AWG and a maximum of 16 AWG.

- The REPO switch wiring must be in accordance with NEC Article 725 Class 2 requirements.
- The maximum distance between the REPO and the UPS cannot exceed 150 meters (500 feet).
- Alarm relay contacts have a maximum current rating of 5A and a switched voltage rating of 30 Vac.
- Alarm relay wiring should be a minimum of 18 AWG (recommended 18 AWG).

3.3 Inspecting and Unpacking the UPS Cabinets

The cabinet is shipped bolted to a metal and wood pallet (see Figure 3-10 or Figure 3-11) with outer protective packaging material covering the cabinet.

 **NOTE** Startup and operational checks must be performed by an authorized Eaton Customer Service Engineer, or the warranty terms specified on page W-1 become void. This service is offered as part of the sales contract for the UPS. Contact an Eaton service representative in advance (a minimum two-week notice is required) to reserve a preferred startup date.

 **WARNING**

The UPS cabinet is heavy (see Table 3-2). If unpacking and unloading instructions are not closely followed, the cabinet may tip and cause serious injury.

1. Carefully inspect the outer packaging for evidence of damage during transit.
-

 **CAUTION**

Do not install a damaged cabinet. Report any damage to the carrier and contact an Eaton service representative immediately.

 **NOTE** For the following step, verify that the forklift or pallet jack is rated to handle the weight of the cabinet (see Table 3-2 for cabinet weight).

2. Use a forklift or pallet jack to move the packaged cabinet to the installation site, or as close as possible, before unpacking. If possible, move the cabinet using the pallet. Insert the forklift or pallet jack forks between the supports on the bottom of the pallet (see Figure 3-6 or Figure 3-7 for the UPS cabinet center of gravity measurements).
-

 **CAUTION**

Do not tilt the UPS cabinet more than 10° from vertical or the cabinet may tip over.

3. Set the pallet on a firm, level surface, allowing a minimum clearance of 3m (10 ft) on each side for removing the cabinet from the pallet.
4. Remove the protective packaging material from the cabinet and recycle in a responsible manner. Retain any parts kits packaged with the cabinet.
5. Inspect the contents for any evidence of physical damage, and compare each item with the Bill of Lading. If damage has occurred or shortages are evident, contact an Eaton service representative immediately to determine the extent of the damage and its impact on further installation.

NOTE While waiting for installation, protect the unpacked cabinet from moisture, dust, and other harmful contaminants. Failure to store and protect the UPS properly may void the warranty.

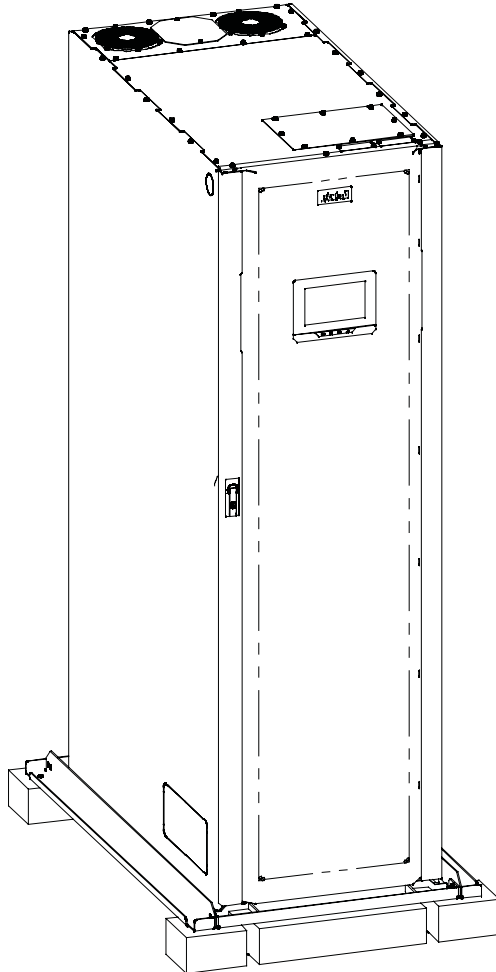
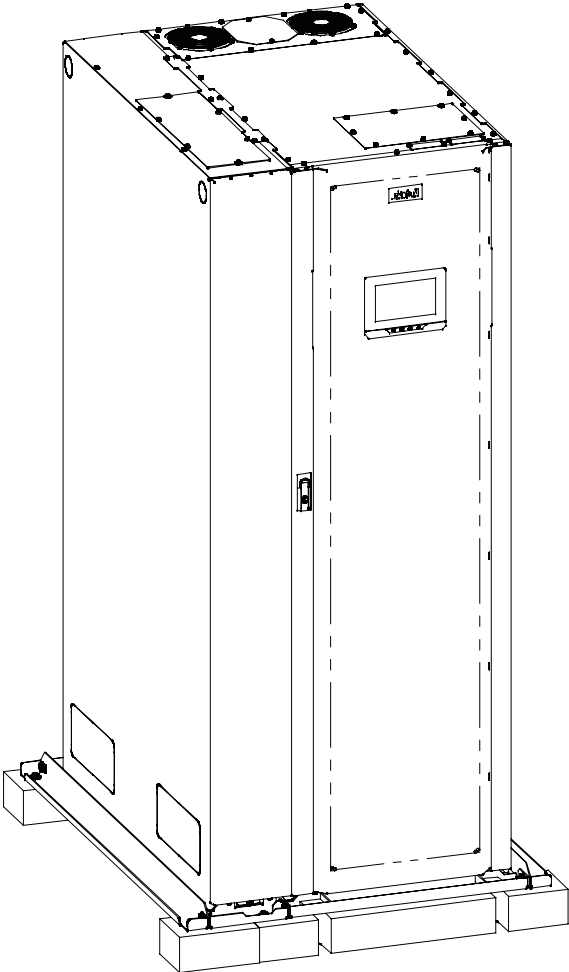
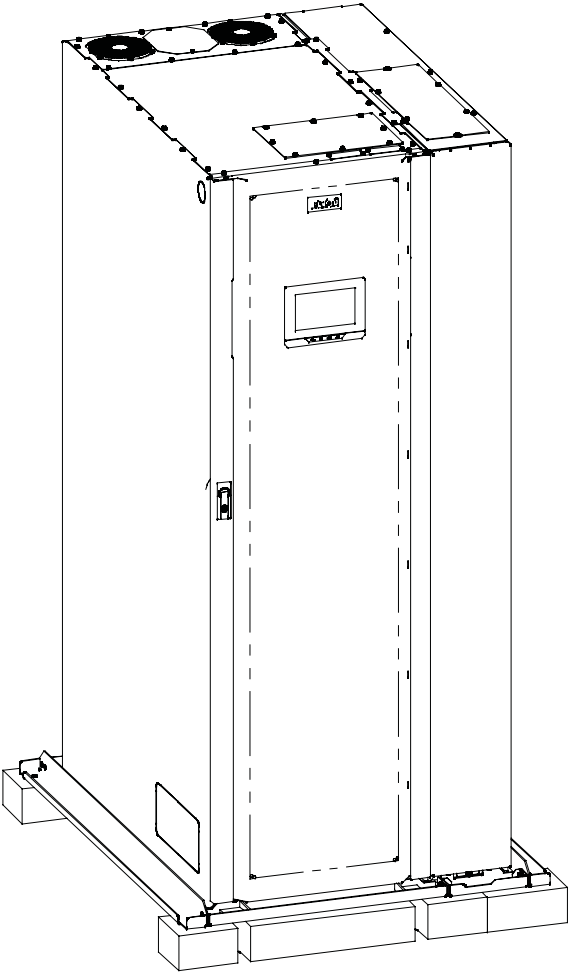

Figure 3-10. UPS Cabinet as Shipped on Pallet



UPS with Left-Mounted Sidecar



UPS with Right-Mounted Sidecar

Figure 3-11. UPS Cabinet with Left-Mounted or Right-Mounted Sidecar as Shipped on Pallet

Chapter 4 UPS System Installation

4.1 Preliminary Installation Information

 **WARNING**

Installation should be performed only by qualified personnel.

Refer to the following while installing the UPS system:

- Chapter 3 for cabinet dimensions, equipment weight, wiring and terminal data, and installation notes.
- Do not tilt the cabinets more than $\pm 10^\circ$ during installation.
- Remove conduit landing plates to add conduit landing holes as required.
- If perforated floor tiles are required for ventilation, place them in front of the UPS.

4.2 Unloading the UPS Cabinet from the Pallet

 **WARNING**

The UPS cabinet is heavy (see Table 3-2). If unpacking and unloading instructions are not closely followed, the cabinet may tip and cause serious injury.

 **CAUTION**

- Do not tilt cabinet more than 10° from vertical.
 - Lift the cabinets only with a forklift or damage may occur.
-

 **NOTE** For the following steps, verify that the forklift or pallet jack is rated to handle the weight of the cabinet (see Table 3-2 for cabinet weight)

The UPS cabinet is bolted to a pallet consisting of four metal angle supports secured to two wood supports.

To remove the pallet:

1. If not already accomplished, use a forklift or pallet jack to move the UPS cabinet to the installation area, or as close as possible, before unloading from the pallet. Insert the forklift or pallet jack forks between the supports on the bottom of the pallet (see Figure 3-6 or Figure 3-7 for the UPS cabinet center of gravity measurements).
2. Open the front door by lifting the latch from the bottom and turning to the right (counterclockwise) and swing the door open.
3. Locate the four 1/2" jacking bolts from the parts kit and install them in the threaded holes in the front and rear supports as shown in Figure 4-1. Place a floor protector from the parts kit underneath each jacking bolt, and screw the bolts down against them.

The floor protectors protect the floor from being marred by the jacking bolts.

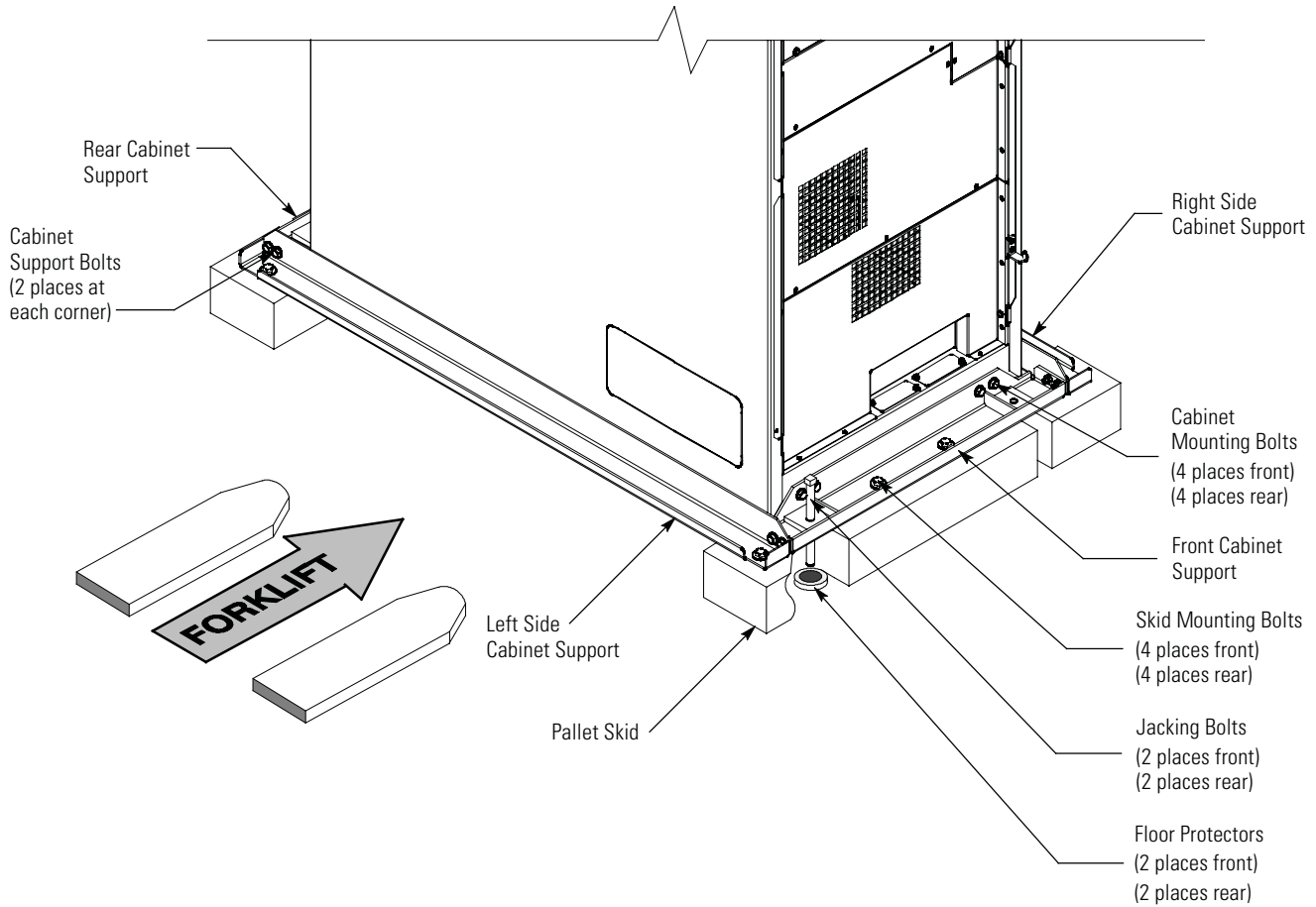

Figure 4-1. Removing the Pallet Skids and Supports – Eaton 93PM UPS

⚠ WARNING

Do not remove or loosen the cabinet mounting or cabinet support bolts until instructed.

4. Loosen, but do not remove, the skid mounting bolts holding the pallet skids to the front and rear supports, and to the left and right side supports (see Figure 4-1).
5. If a sidecar is attached to the UPS, loosen, but do not remove, the sidecar skid mounting bolts holding the sidecar pallet skids to the sidecar front and rear supports, and to the left and right supports (see Figure 4-1 and Figure 4-2).

⚠ WARNING

RISK OF INSTABILITY. Turning the jacking bolts unevenly may cause the cabinet to become unbalanced. To prevent tipping the cabinet, raise and lower the jacking bolts evenly.

⚠ CAUTION

CABINET MAY TIP. Raise the UPS no more than 3 mm (1/8") above the floor (just enough to allow the removal of the pallet skids).

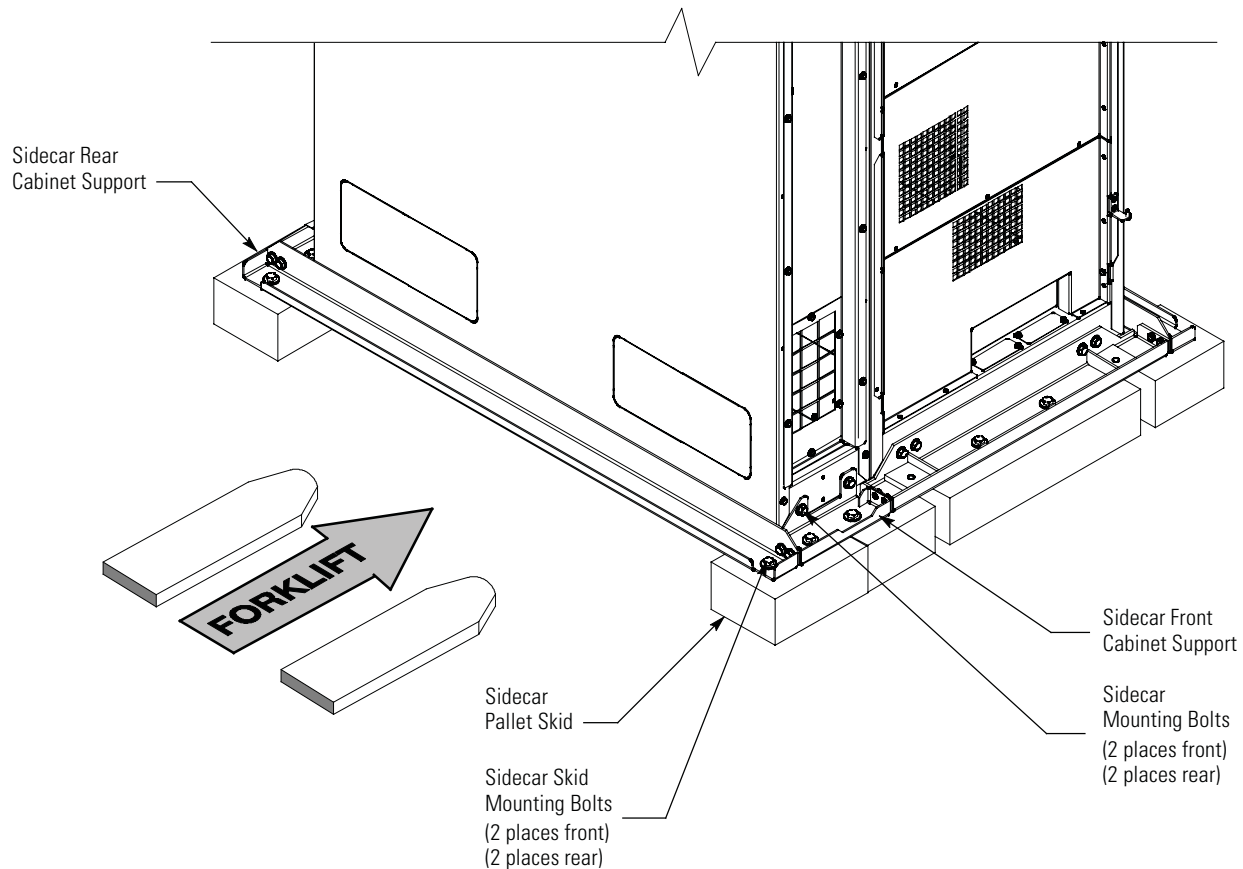

Figure 4-2. Removing the Sidecar Pallet Skids and Supports – Eaton 93PM UPS

6. Turn each jacking bolt consecutively, two full turns, until the pallet skids clear the floor by approximately 3 mm (1/8").
7. Remove the hardware loosened in Step 4.
8. If a sidecar is attached to the UPS, remove the hardware loosened in Step 5.
9. Pull the pallet skids out from under the metal angle supports without disturbing the jacking bolts. Recycle the pallet skids and hardware in a responsible manner.

CAUTION

CABINET MAY FALL. Do not loosen the hardware attaching the front supports to the cabinet base. The cabinet must be lowered by the jacking bolts before the supports can be removed.

10. Carefully and evenly **lower the cabinet by turning each jacking bolt consecutively two full turns (maximum)** until the casters contact the floor and the cabinet is no longer supported by the jacking bolts.
11. After the UPS is resting on the floor, remove the jacking bolts and floor protectors. Recycle them in a responsible manner.
12. Remove the cabinet support bolts fastening the front, rear, and side cabinet supports together and remove the side supports (see Figure 4-1).
13. If a sidecar is attached to the UPS, remove the bottom screw securing the sidecar front panel. Lift the panel straight up to remove from the panel hanger brackets at the top of the cabinet.

14. If a sidecar is attached to the UPS, remove the sidecar mounting bolts holding the front and rear sidecar supports to the cabinet base (see Figure 4-2).
15. Remove the cabinet mounting bolts holding the front and rear supports to the cabinet base (see Figure 4-1).
16. If installing the cabinet permanently, retain the cabinet mounting bolts; otherwise, recycle the bolts along with the support brackets in a responsible manner.
17. Close the door and secure the latch.
18. If a sidecar is attached to the UPS, remove the screws securing sidecar rear shipping bracket. Remove the bracket and reinstall the screws (see Figure 4-3).
19. If the leveling feet are not retracted, turn all four leveling feet until they are retracted as far into the cabinet as possible.

 **CAUTION**

To prevent tipping when rolling the cabinet, push the cabinet from the rear whenever possible.

20. Roll the cabinet to the final installation location.



NOTE Use the leveling feet to level and lock the cabinet in place.

21. Secure the UPS in position by lowering the leveling feet until the cabinet is level and locked in place.



NOTE Either front and back floor mounting brackets or left and right side floor mounting brackets are available for permanently mounting the UPS.

22. If permanently mounting the UPS using the left and right side floor mounting brackets, proceed to Step 23; if using the front and rear floor mounting brackets, proceed to Step 27; otherwise, proceed to Step 30.
23. Locate the left and right side floor mounting brackets from the floor mounting kit.
24. Using the retained cabinet mounting bolts, install the floor mounting brackets to the left and right side of the UPS with the angle facing outward.
25. Secure the cabinet to the floor with customer-supplied hardware.
26. Proceed to paragraph 4.3.
27. Locate the front and back floor mounting brackets from the floor mounting kit.
28. Using the retained cabinet mounting bolts, install the floor mounting brackets to the front and rear of the UPS with the angle facing outward.
29. Secure the cabinet to the floor with customer-supplied hardware.



NOTE Black cover dots are provided, if side mounting bracket holes need to be covered for aesthetic reasons.

30. Locate the black cover dots from the parts kit and install over the left and right side bracket mounting holes.
31. Proceed to paragraph 4.3

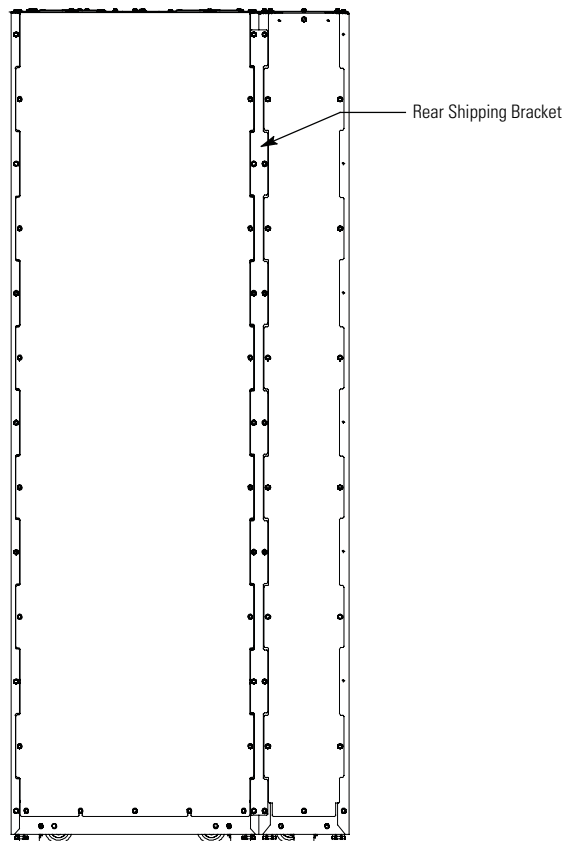

Figure 4-3. Removing the Sidecar Rear Shipping Bracket – Eaton 93PM UPS

4.3 Integrated Battery Cabinet Installation

If installing Integrated Battery Cabinets (IBCs), refer to the *Eaton 93PM Integrated Battery Cabinet Installation Manual – Large and Large High Rate* or the *Eaton 93PM Integrated Battery Cabinet Installation Manual-Small*, listed in paragraph 1.8, for installation instructions.

After the IBC is installed, proceed to paragraph 4.4 if a Sidecar Integrated Accessory Cabinet-Bypass (SIAC-B) is attached to the UPS, or to paragraph 4.5 if a Sidecar Integrated Accessory Cabinet-Tie (SIAC-T) is attached to the UPS, or to paragraph 4.6 if a Sidecar Integrated Accessory Cabinet-Tie Bypass (SIAC-TB) is attached to the UPS, or to paragraph 4.7 if installing an Integrated Accessory Cabinet-Tie (IAC-T), or to paragraph 4.8 if installing an Integrated Accessory Cabinet-Distribution (IAC-D); otherwise, proceed to paragraph 4.9 to complete the wiring of the UPS.

4.4 Sidecar Integrated Accessory Cabinet-Bypass Wiring Installation

If an SIAC-B is attached to the UPS, refer to the *Eaton 93PM Sidecar Integrated Accessory Cabinet-Bypass Installation and Operation (50 kW and 100 kW SIAC-B) Manual* listed in paragraph 1.8 for wiring installation instructions.

After the SIAC-B is wired, proceed to paragraph 4.7 if installing an Integrated Accessory Cabinet-Tie (IAC-T), or to paragraph 4.8 if installing Integrated Accessory Cabinet-Distribution; otherwise, proceed to paragraph 4.9 to complete the wiring of the UPS.

4.5 Sidecar Integrated Accessory Cabinet-Tie Wiring Installation

If an SIAC-T is attached to the UPS, refer to the *Eaton 93PM Sidecar Integrated Accessory Cabinet-Tie and Tie Bypass (50 kW and 100 kW SIAC-T, and 50 kW and 100 kW SIAC-TB) Installation and Operation Manual* listed in paragraph 1.8 for wiring installation instructions.

After the SIAC-T is wired, proceed to paragraph 4.8 if installing Integrated Accessory Cabinet-Distribution; otherwise, proceed to paragraph 4.9 to complete the wiring of the UPS.

4.6 Sidecar Integrated Accessory Cabinet-Tie Bypass Wiring Installation

If an SIAC-TB is attached to the UPS, refer to the *Eaton 93PM Sidecar Integrated Accessory Cabinet-Tie and Tie Bypass (50 kW and 100 kW SIAC-T, and 50 kW and 100 kW SIAC-TB) Installation and Operation Manual* listed in paragraph 1.8 for wiring installation instructions.

After the SIAC-TB is wired, proceed to paragraph 4.8 if installing Integrated Accessory Cabinet-Distribution; otherwise, proceed to paragraph 4.9 to complete the wiring of the UPS.

4.7 Integrated Accessory Cabinet-Tie

If an IAC-T is attached to the UPS, refer to the *Eaton 93PM Integrated Accessory Cabinet-Tie (50 kW and 100 kW IAC-T) Installation and Operation Manual* listed in paragraph 1.8 for wiring installation instructions.

After the IAC-T is wired, proceed to paragraph 4.8 if installing Integrated Accessory Cabinet-Distribution; otherwise, proceed to paragraph 4.9 to complete the wiring of the UPS.

4.8 Integrated Accessory Cabinet-Distribution

If installing Integrated Accessory Cabinet-Distribution (IAC-D), refer to the *Eaton 93PM Integrated Accessory Cabinet-Distribution (50 kW, 100 kW, 150 kW, and 200 kW IAC-D) Installation and Operation Manual* listed in paragraph 1.8 for installation instructions.

After the IAC-D is installed, proceed to paragraph 4.9 to complete the wiring of the UPS.

4.9 External AC Power Wiring Installation

To install wiring:

1. Open the front door by lifting the latch from the bottom and turning to the right (counterclockwise) and swing the door open.
2. Remove the screws securing the bottom internal safety shield panel and remove the panel to gain access to the input, output, and battery power wiring terminals. Retain the hardware for later use.
3. If wiring the UPS using the top entry sidecar, proceed to Step 7; otherwise proceed to Step 4.
4. **Bottom Entry Wiring.** Remove the bottom conduit plate (see Figure 4-4) from the inside bottom of the UPS. Identify all conduit requirements and mark their location. Drill and punch all conduit holes in the bottom conduit plate prior to mounting on the UPS. Install the conduit plate and install all conduit runs into the plate. Pull the wiring through conduit into the wiring area.
5. Route the input and output cables through the bottom of the cabinet to the UPS terminals. See Figure 4-4 for wiring access information and Figure 4-7 for terminal locations.
6. Proceed to Step 11.
7. If not already accomplished, remove the bottom screw securing the sidecar front panel. Lift the panel straight up to remove from the panel hanger brackets at the top of the cabinet.
8. Remove the screws securing the sidecar internal safety shield panel and remove the panel to gain access to the interior of the sidecar and the UPS inter-cabinet wiring access pass-through. Retain the hardware for later use.

9. **Top Entry Wiring.** Remove the top conduit plate (see Figure 4-5) from the top of the sidecar. Identify all conduit requirements and mark their location. Drill and punch all conduit holes in the top conduit plate prior to mounting on the sidecar. Install the conduit plate and install all conduit runs into the plate. Pull the wiring through the conduit into the wiring area.
10. Route the input and output cables through the top of the UPS sidecar and the UPS inter-cabinet wiring access pass-through to the UPS terminals. See Figure 4-5 and Figure 4-6 for wiring access information and Figure 4-7 for terminal locations.
11. Connect phase A, B, and C rectifier input power wiring from the utility source to the rectifier input terminals. See paragraph 3.2.2 for wiring and termination requirements.
For a detailed view of the UPS terminal blocks, see Figure 4-8.
12. Connect phase A, B, and C bypass input power wiring from the utility source to the bypass input terminals. See paragraph 3.2.2 for wiring and termination requirements.
For a detailed view of the UPS terminal blocks, see Figure 4-8.
13. If wiring an external parallel system, proceed to Step 14; otherwise, proceed to Step 16.

 **CAUTION**

External parallel system wiring length should be in accordance with Figure 3-9, to ensure approximately equal current sharing when in Bypass mode.

14. Connect phase A, B, and C power wiring from the output terminals of each UPS to the tie cabinet.
For a detailed view of the UPS terminal blocks, see Figure 4-8.
15. Proceed to Step 17.
16. Connect phase A, B, and C power wiring from output terminals to the critical load. See paragraph 3.2.2 for wiring and termination requirements.
For a detailed view of the UPS terminal blocks, see Figure 4-8.

 **WARNING**

As a result of the connected loads high leakage current is possible. Connection to earth ground is required for safety and proper product operation. Do not check UPS operation by any action that includes removal of the earth (ground) connection with loads attached.

17. Ground the UPS according to local and/or national electrical wiring codes by routing and connecting the ground wire to the input ground lug. See Figure 4-7 for UPS terminal locations.
For a detailed view of the UPS ground terminals, see Figure 4-8.
18. Proceed to paragraph 4.10.

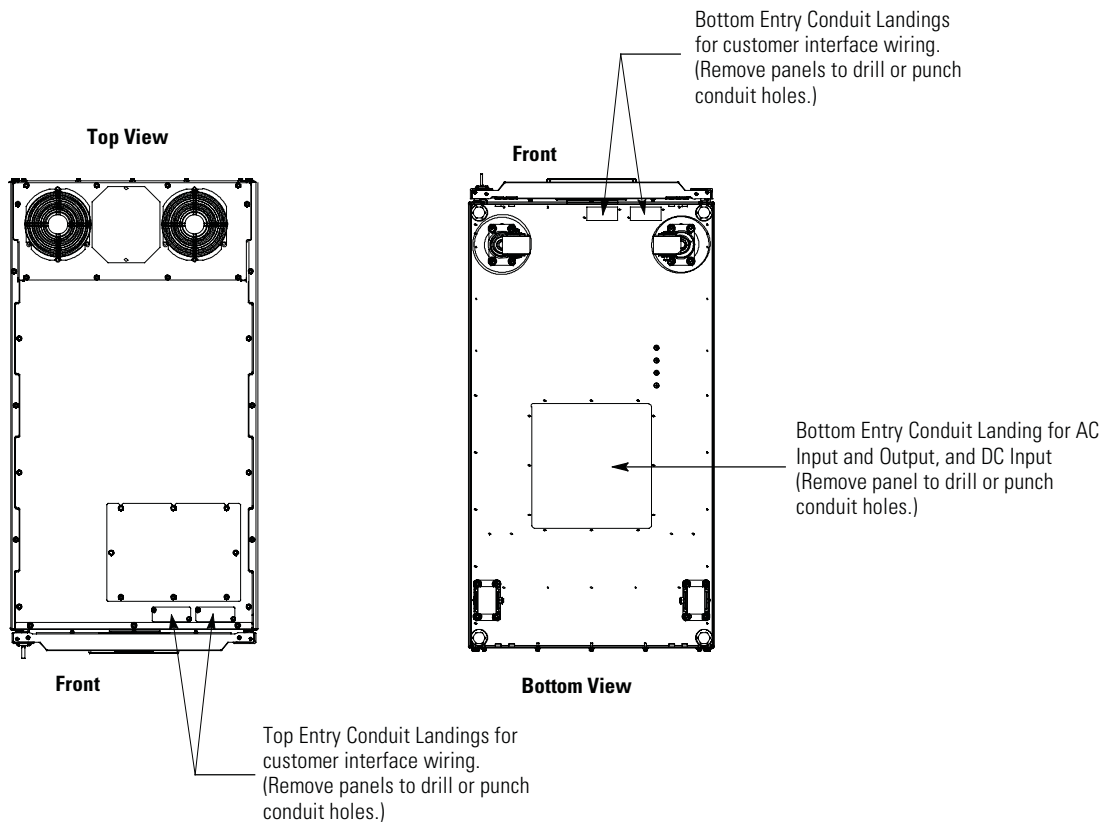

Figure 4-4. UPS Conduit and Wire Entry Locations

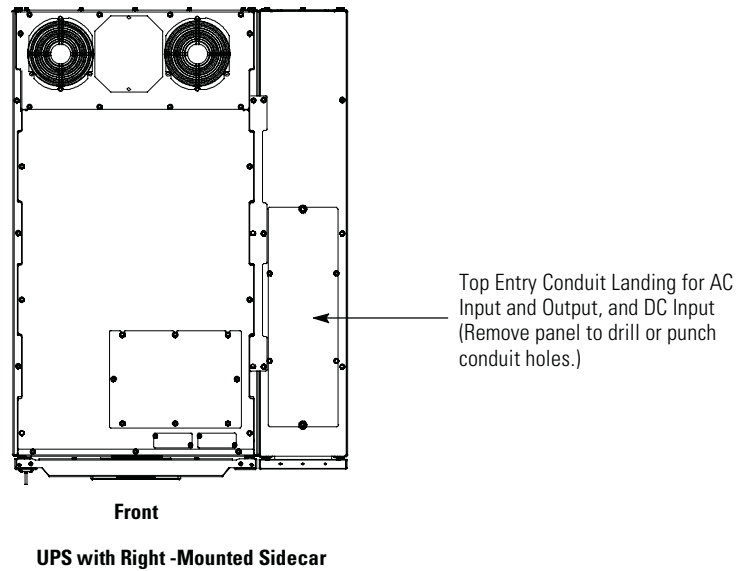
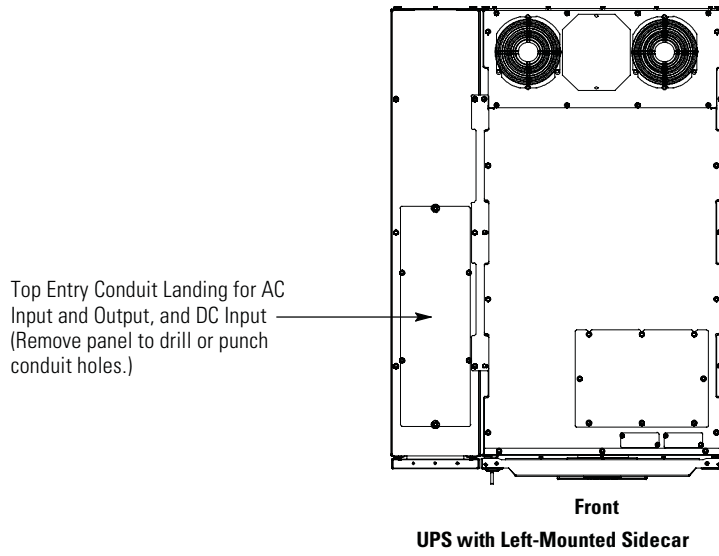

Figure 4-5. Sidecar Conduit and Wire Entry Locations

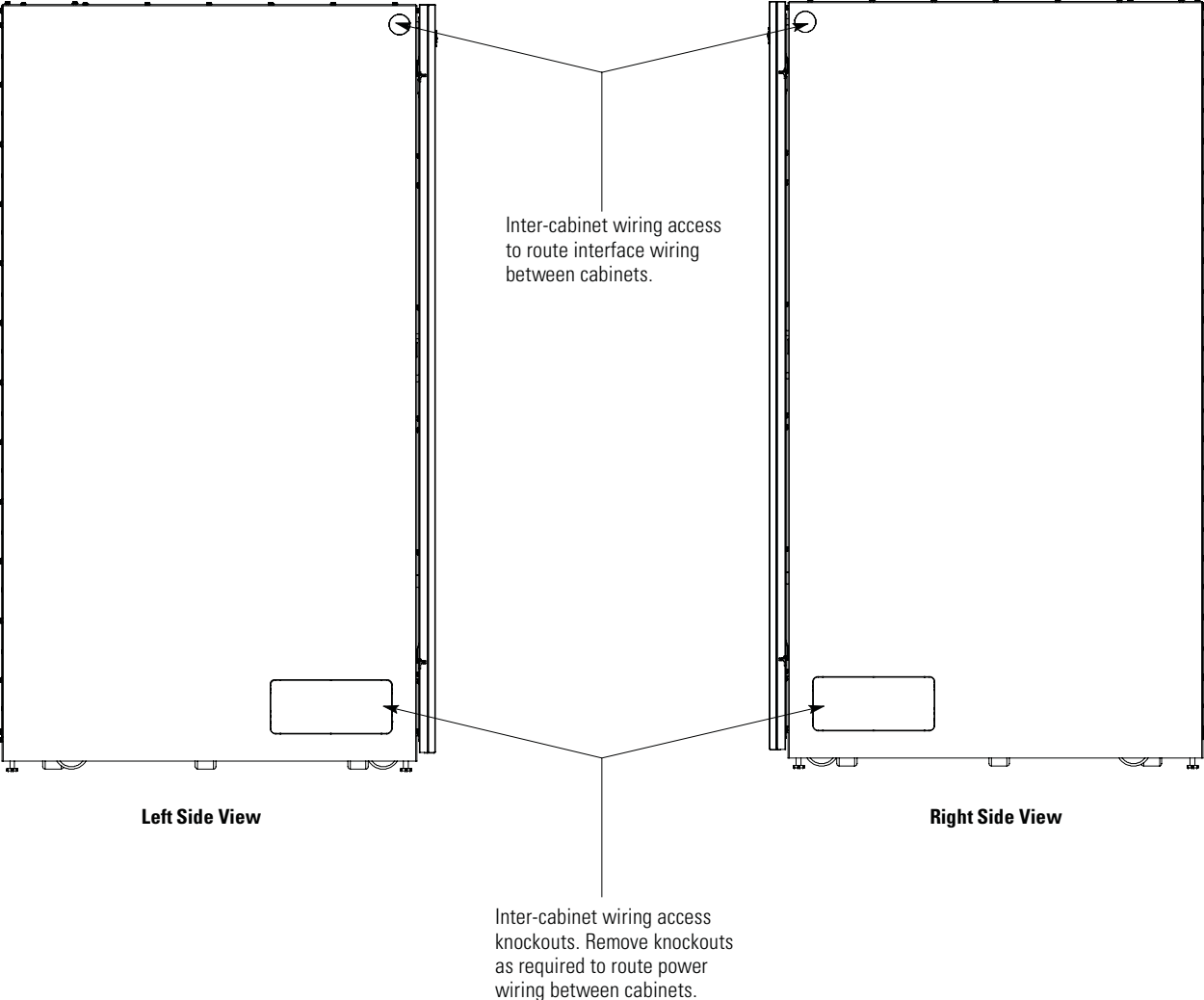

Figure 4-6. UPS Inter-Cabinet Wiring Access Location

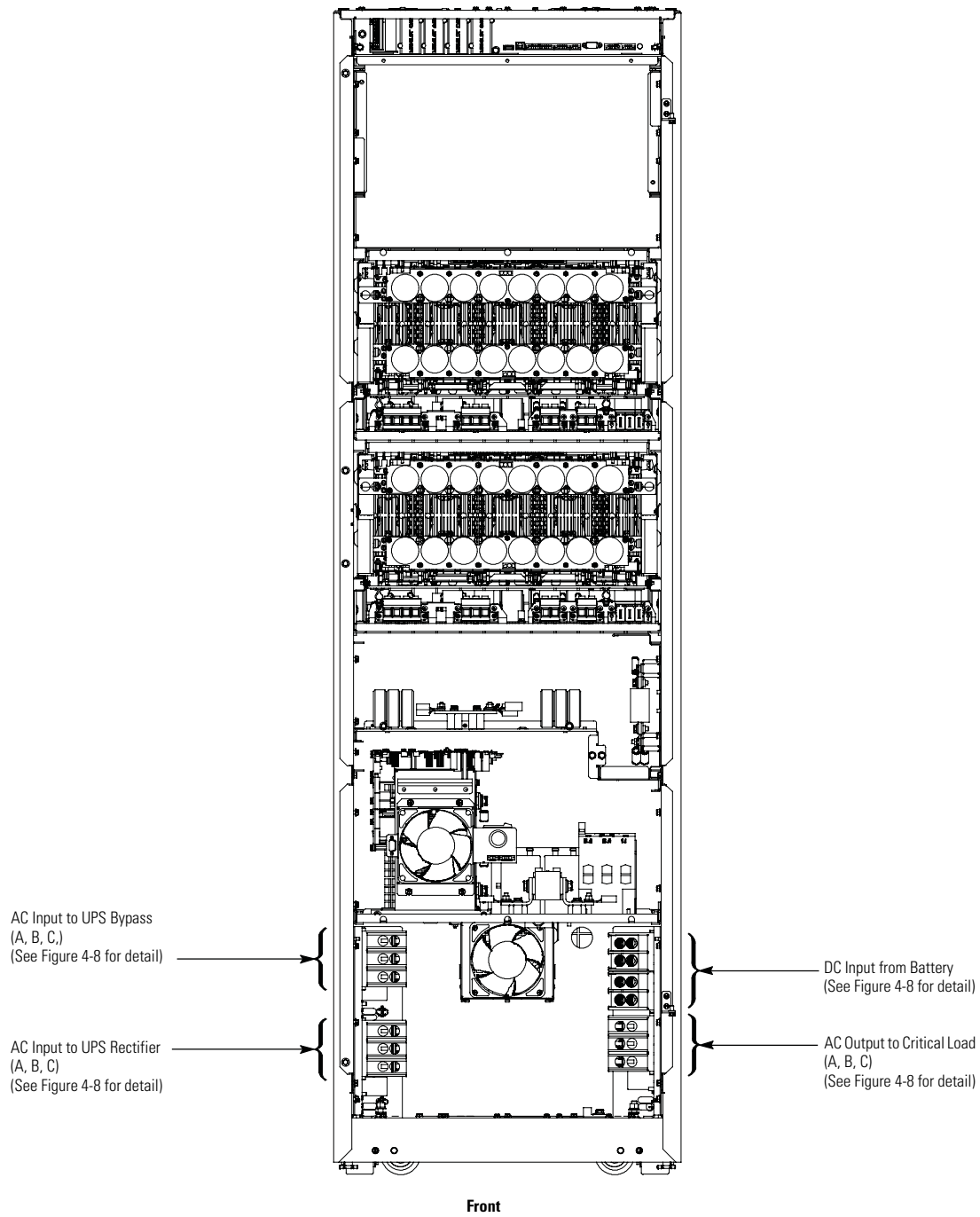

Figure 4-7. Power Terminal Locations

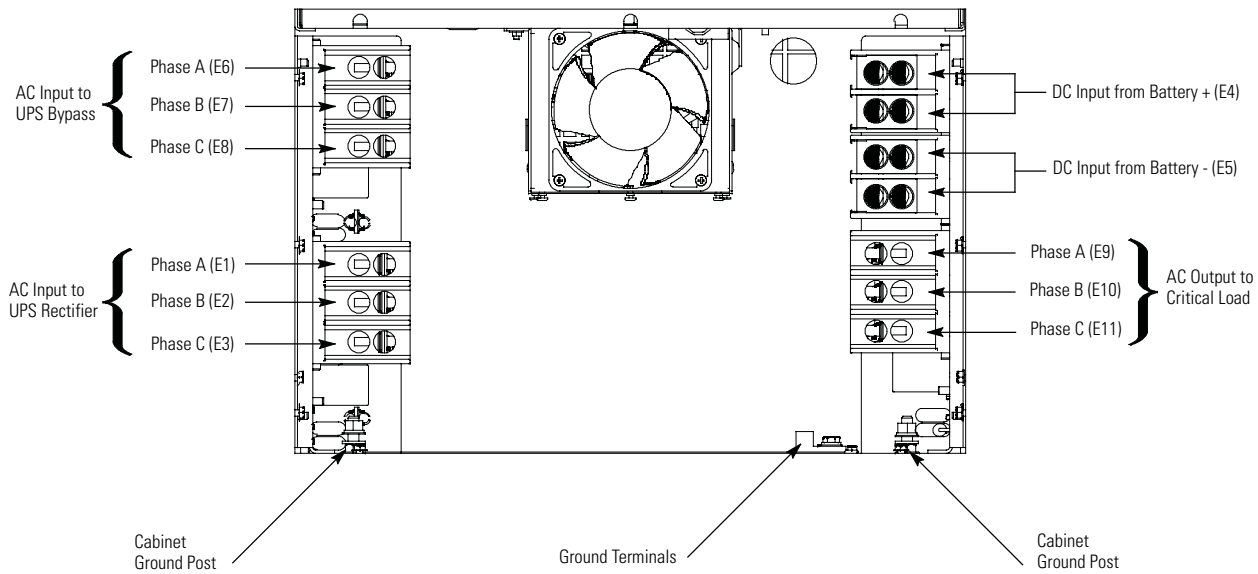

Figure 4-8. Power Terminal Detail

4.10 Battery Power Wiring

⚠ CAUTION

When sizing the battery system, do not exceed the internal battery charger capabilities. See Chapter 9, "Product Specifications," for maximum battery charger currents.

To install wiring:

1. Route and connect the battery cables between the UPS and battery cabinet or battery disconnect according to the instructions in the *Eaton 93PM Integrated Battery Cabinet Installation Manual – Large and Large High Rate* or the *Eaton 93PM Integrated Battery Cabinet Installation Manual-Small*, listed in paragraph 1.8. See Figure 4-4, Figure 4-5, and Figure 4-6 for wiring access information and Figure 4-7 for terminal locations.
2. Connect the positive, negative, and ground DC power wiring from the battery cabinet or disconnect to the UPS cabinet battery and ground terminals. See paragraph 3.2.2 for wiring and termination requirements
For a detailed view of the UPS terminal block, see Figure 4-8.
3. After wiring the UPS system to the facility power and critical load, be sure to ground the system according to local and/or national electrical wiring codes.
4. If wiring interface connections, proceed to paragraph 4.11; otherwise, proceed to Step 5.
5. Reinstall all safety shield panels previously removed and secure with the retained hardware.
6. If removed, reinstall the sidecar front panel and secure with the retained hardware.
7. Close the UPS outside door and secure the latch.

4.11 Installing Interface Connections



NOTE If installing the IAC-D CT wiring, refer to the *Eaton 93PM Integrated Accessory Cabinet-Distribution (50 kW, 100 kW, 150 kW, and 200 kW IAC-D) Installation and Operation Manual* listed in paragraph 1.8 for installation instructions.

Use the procedures in the following paragraphs to connect the customer and battery interface connections.

4.11.1 Installing Building Alarm and Relay Contact Connections



NOTE 1 If installing interface wiring connections between standalone cabinets or separate devices, conduit must be installed between each cabinet or device.

NOTE 2 Disconnect terminal block plugs from terminal blocks to wire plugs.

To install wiring:

1. Verify the UPS system is turned off and all power sources are removed. See Chapter 6, “UPS Operating Instructions,” for shutdown instructions.
2. If not already opened, open the front door by lifting the latch from the bottom and turning to the right (counterclockwise) and swing the door open.
3. If wiring the interface terminals from the bottom of the UPS, proceed to Step 8; otherwise, proceed to Step 4.
4. **Top Entry Wiring.** Remove the top interface entry conduit landing plates to drill or punch holes (see Figure 4-4).
5. Reinstall the interface entry plates and install the conduit.
6. Route the UPS building alarm and relay output interface wiring through the top interface entry conduit landing plates to the UPS building alarm and relay output terminals. See Figure 4-4 for wiring access information and Figure 4-9 and Figure 4-10 for UPS interface terminal locations.
7. Proceed to Step 13.
8. **Bottom Entry Wiring.** Remove the bottom interface entry conduit landing plates to drill or punch holes (see Figure 4-11).
9. Reinstall the interface entry plates and install the conduit.
10. Route the UPS building alarm and relay output interface wiring through the bottom interface entry conduit landing plates to the bottom access interface wiring channel along the inside of the front door (see Figure 4-11).
11. Route the wiring along the interface wiring channel (see Figure 4-11) to the UPS building alarm and relay output terminals. See Figure 4-9 and Figure 4-10 for UPS interface terminal locations.
12. Secure the wiring to the wire tie anchors provided (see Figure 4-12) using Zip ties.
13. Connect the building alarm interface wiring to the building alarm terminals. See paragraph 3.2.4 and Table 4-3 for wiring and termination requirements, and Figure 4-13 for terminal assignments.
14. Connect the relay output interface wiring to the relay output terminals. See paragraph 3.2.4 and Table 4-3 for wiring and termination requirements, and Figure 4-14 for terminal assignments.

UPS System Installation

15. If wiring battery detect connections, proceed to paragraph 4.11.2; if wiring battery shunt trip connections, proceed to paragraph 4.11.3; if wiring external parallel CAN connections, proceed to paragraph 4.11.5; if wiring external parallel pull chain connections, proceed to paragraph 4.11.6; if wiring Minislot connections, proceed to paragraph 4.11.7; if wiring REPO connections, proceed to paragraph 4.12; otherwise, proceed to Step 16.
16. Close the UPS outside door and secure the latch.

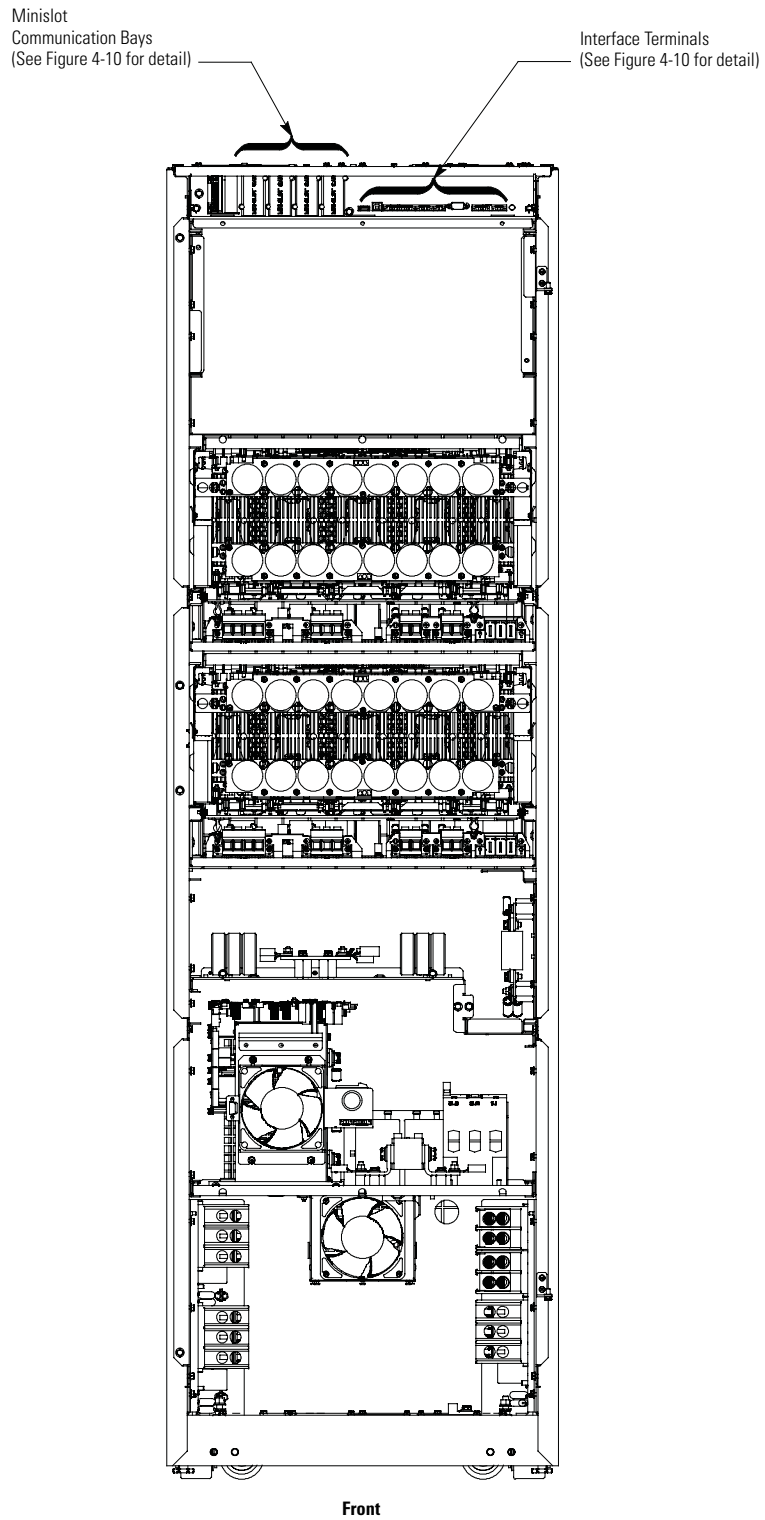

Figure 4-9. Interface Terminal Locations

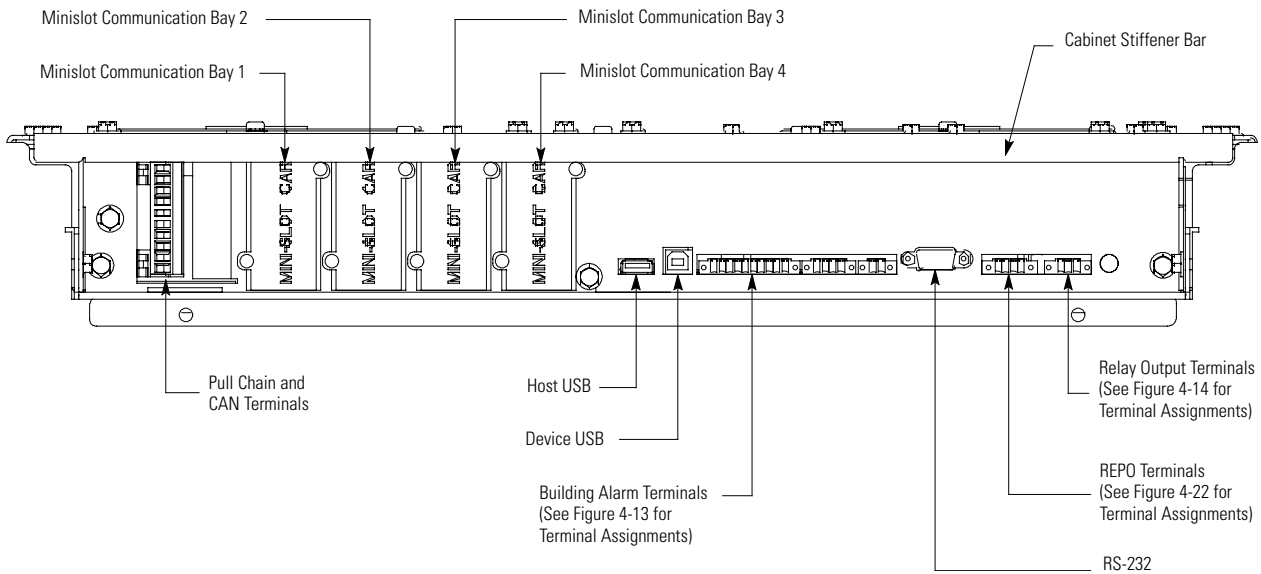

Figure 4-10. Interface Terminal Detail

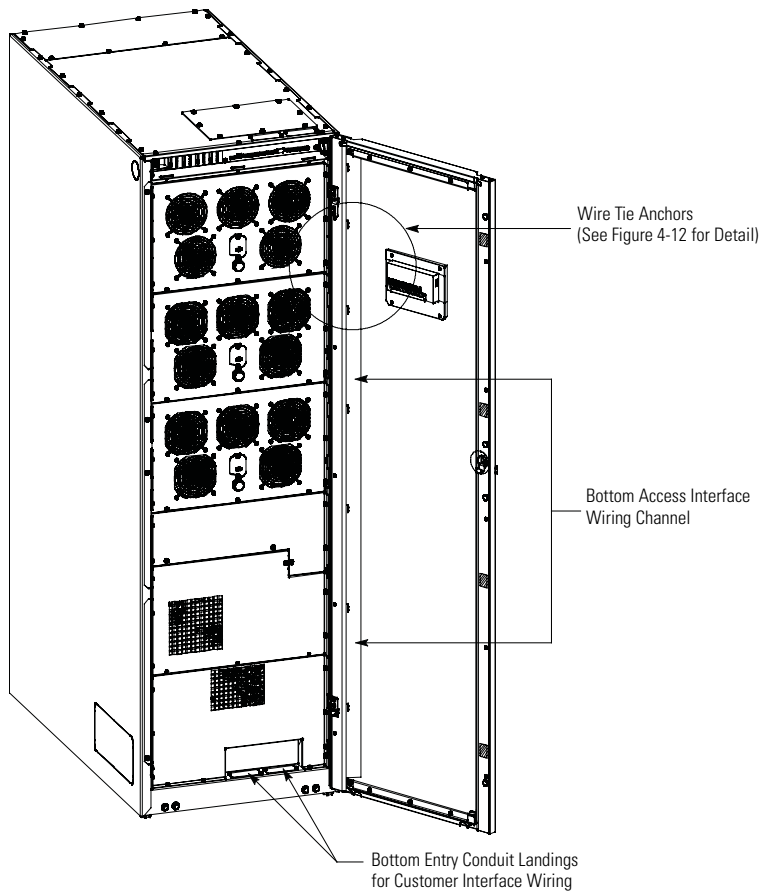

Figure 4-11. Bottom Access Interface Wiring Location

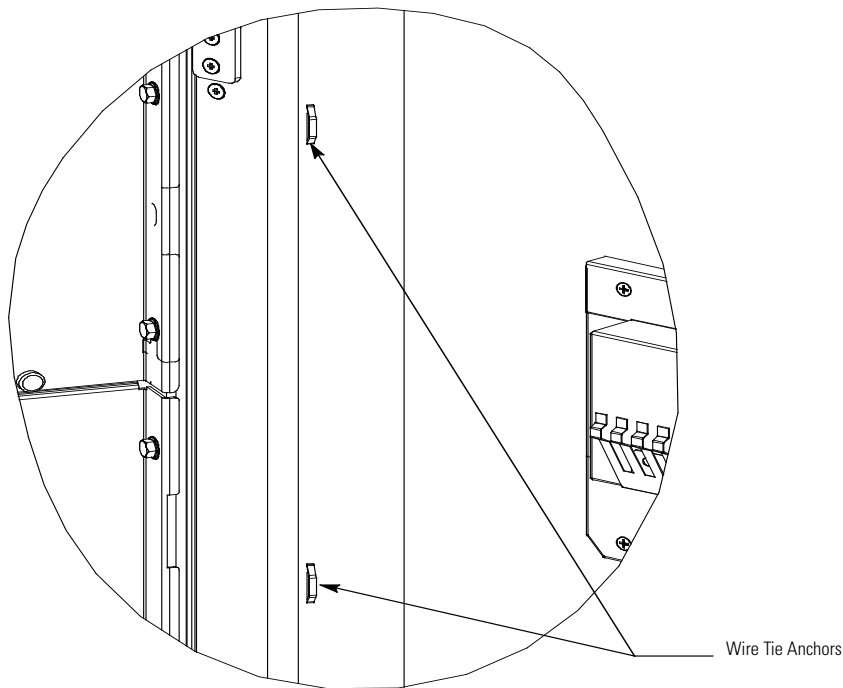

Figure 4-12. Wire Tie Anchors

Table 4-1. Building Alarm Connections and Wire Terminations

Terminal	Name	Description	Recommended Wire Size	Size of Pressure Termination	Tightening Torque
10	Building Alarm 1	Input: Programmable UPS alarm, activated by a remote dry contact closure	Twisted Pair Wires #18 AWG	#14–#30 AWG	2 lb in (0.22-0.25 Nm)
9	Building Alarm 1 Return				
8	Building Alarm 2	Input: Programmable UPS alarm, activated by a remote dry contact closure	Twisted Pair Wires #18 AWG	#14–#30 AWG	2 lb in (0.22-0.25 Nm)
7	Building Alarm 2 Return				
6	Building Alarm 3	Input: Programmable UPS alarm, activated by a remote dry contact closure	Twisted Pair Wires #18 AWG	#14–#30 AWG	2 lb in (0.22-0.25 Nm)
5	Building Alarm 3 Return				
4	Building Alarm 4	Input: Programmable UPS alarm, activated by a remote dry contact closure	Twisted Pair Wires #18 AWG	#14–#30 AWG	2 lb in (0.22-0.25 Nm)
3	Building Alarm 4 Return				
2	Building Alarm 5	Input: Programmable UPS alarm, activated by a remote dry contact closure	Twisted Pair Wires #18 AWG	#14–#30 AWG	2 lb in (0.22-0.25 Nm)
1	Building Alarm 5 Return				

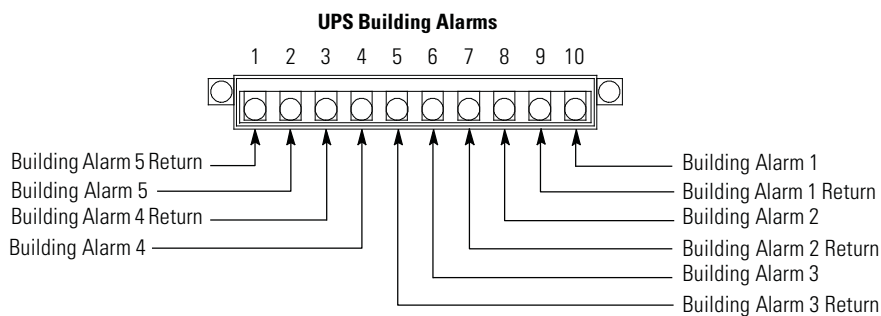

Figure 4-13. Building Alarm Terminal Block Connector Assignments

Table 4-2. Relay Contact Connections and Wire Terminations

Terminal	Name	Description	Recommended Wire Size	Size of Pressure Termination	Tightening Torque
1	Relay Contact NC	Output: General purpose normally-closed (NC) relay contact.	Twisted Pair Wires #18 AWG	#14–#30 AWG	2 lb in (0.22-0.25 Nm)
3	Relay Contact Common				
2	Relay Contact NO	Output: General purpose normally-closed (NO) relay contact.	Twisted Pair Wires #18 AWG	#14–#30 AWG	2 lb in (0.22-0.25 Nm)
3	Relay Contact Common				

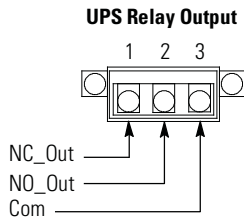

Figure 4-14. Relay Contact Terminal Block Connector Assignments

4.11.2 Installing Battery Detect Interface Connections

- NOTE 1** The UPS battery detect signal uses an UPS building alarm input to indicate an open battery breaker.
- NOTE 2** Any pair of unused building alarm terminals may be used for the battery detect connections.
- NOTE 3** Program the battery detect building alarm to read battery open and for normally open contacts.
- NOTE 4** If installing interface wiring connections between standalone cabinets, conduit must be installed between cabinets.
- NOTE 5** Disconnect terminal block plugs from terminal blocks to wire plugs.

To install wiring:

1. Verify the UPS system is turned off and all power sources are removed. See Chapter 6, “UPS Operating Instructions,” for shutdown instructions.
2. If not already opened, open the front door by lifting the latch from the bottom and turning to the right (counterclockwise) and swing the door open.
3. If wiring the battery detect connections using the inter-cabinet wiring access pass-through (line-up-and-match configurations), proceed to Step 4; if wiring the battery interface connections using bottom entry access, proceed to Step 6; if wiring the battery interface connections using top entry access, proceed to Step 12.
4. **Pass-through Wiring.** Route the battery detect wiring from the battery cabinet through the top UPS inter-cabinet wiring access pass-through to the UPS building alarm terminals. See Figure 4-6 for UPS wiring access information and Figure 4-9 and Figure 4-10 for UPS terminal locations. Refer to the *Eaton 93PM Integrated Battery Cabinet Installation Manual – Large and Large High Rate* or the *Eaton 93PM Integrated Battery Cabinet Installation Manual-Small*, listed in paragraph 1.8 for battery cabinet wiring access information and instructions.
5. Proceed to Step 15.

6. **Bottom Entry Wiring.** Remove the bottom interface entry conduit landing plate to drill or punch holes (see Figure 4-11).
7. Reinstall the interface entry plate and install the conduit.
8. Route the battery detect wiring from the battery cabinet through the bottom interface entry conduit landing plate to the bottom access interface wiring channel along the inside of the front door (see Figure 4-11). Refer to the *Eaton 93PM Integrated Battery Cabinet Installation Manual – Large and Large High Rate* or the *Eaton 93PM Integrated Battery Cabinet Installation Manual-Small*, listed in paragraph 1.8 for battery cabinet wiring access information and instructions.
9. Route the wiring along the interface wiring channel (see Figure 4-11) to the UPS building alarm terminals. See Figure 4-9 and Figure 4-10 for UPS interface terminal locations.
10. Secure the wiring to the wire tie anchors provided (see Figure 4-12) using Zip ties.
11. Proceed to Step 15.
12. **Top Entry Wiring.** Remove the top interface entry conduit landing plate to drill or punch holes (see Figure 4-4).
13. Reinstall the interface entry plate and install the conduit.
14. Route the battery detect wiring from the battery cabinet through the top interface entry conduit landing plate to the UPS building alarm terminals. See Figure 4-4 for wiring access information and Figure 4-9 and Figure 4-10 for UPS interface terminal locations. Refer to the *Eaton 93PM Integrated Battery Cabinet Installation Manual – Large and Large High Rate* or the *Eaton 93PM Integrated Battery Cabinet Installation Manual-Small*, listed in paragraph 1.8 for battery cabinet wiring access information and instructions.
15. Connect the battery detect wiring to one pair of building alarm terminals. See paragraph 3.2.4 and Table 4-1 for wiring and termination requirements, and Figure 4-13 for terminal assignments.
16. If wiring battery shunt trip connections, proceed to paragraph 4.11.3; if wiring external parallel CAN connections, proceed to paragraph 4.11.5; if wiring external parallel pull chain connections, proceed to paragraph 4.11.6; if wiring Minislot connections, proceed to paragraph 4.11.7; if wiring REPO connections, proceed to paragraph 4.12; otherwise, proceed to Step 17.
17. Close the UPS outside door and secure the latch.

4.11.3 Installing Battery Shunt Trip Interface Connections



NOTE 1 If installing interface wiring connections between standalone cabinets, conduit must be installed between cabinets.

NOTE 2 Disconnect terminal block plugs from terminal blocks to wire plugs.

To install wiring:

1. Verify the UPS system is turned off and all power sources are removed. See Chapter 6, “UPS Operating Instructions,” for shutdown instructions.
2. If not already opened, open the front door by lifting the latch from the bottom and turning to the right (counterclockwise) and swing the door open.
3. If not already removed, remove the screws securing the bottom internal safety shield panel and remove the panel. Retain the hardware for later use.
4. Remove the screws securing the internal safety shield panel above the bottom safety panel and remove the panel to gain access to the battery shunt trip wiring terminals. Retain the hardware for later use.

5. If wiring the battery shunt trip connections using the inter-cabinet wiring access pass-through (line-up-and-match configurations), proceed to Step 6; if wiring the battery shunt trip connections using bottom entry access, proceed to Step 8; if wiring the battery shunt trip connections using top entry access, proceed to Step 10.
6. **Pass-through Wiring.** Route the battery shunt trip wiring from the battery cabinet through the bottom UPS inter-cabinet wiring access pass-through and static switch shelf bushing to the UPS battery shunt trip terminals. See Figure 4-6 for UPS wiring access information and Figure 4-15 and Figure 4-16 for UPS terminal locations. Refer to the *Eaton 93PM Integrated Battery Cabinet Installation Manual – Large and Large High Rate* or the *Eaton 93PM Integrated Battery Cabinet Installation Manual-Small*, listed in paragraph 1.8 for battery cabinet wiring access information and instructions.
7. Proceed to Step 11.
8. **Bottom Entry Wiring.** Route the battery shunt trip wiring from the battery cabinet or battery disconnect through the bottom of the UPS and static switch shelf bushing to the UPS battery shunt trip terminals. See Figure 4-4 for UPS wiring access information and Figure 4-15 and Figure 4-16 for UPS terminal locations. Refer to the *Eaton 93PM Integrated Battery Cabinet Installation Manual – Large and Large High Rate* or the *Eaton 93PM Integrated Battery Cabinet Installation Manual-Small*, listed in paragraph 1.8 for battery cabinet wiring access information and instructions.
9. Proceed to Step 11.
10. **Top Entry Wiring.** Route the battery shunt trip wiring from the battery cabinet or battery disconnect through the top of the UPS sidecar and the bottom UPS inter-cabinet wiring access pass-through and static switch shelf bushing to the UPS battery shunt trip terminals. See Figure 4-5 and Figure 4-6 for UPS wiring access information and Figure 4-15 and Figure 4-16 for UPS terminal locations. Refer to the *Eaton 93PM Integrated Battery Cabinet Installation Manual – Large and Large High Rate* or the *Eaton 93PM Integrated Battery Cabinet Installation Manual-Small*, listed in paragraph 1.8 for battery cabinet wiring access information and instructions.
11. Connect the wiring to the battery shunt trip terminals. See paragraph 3.2.4 and Table 4-3 for wiring and termination requirements, and Figure 4-17 for terminal assignments.
12. If wiring external parallel CAN connections, proceed to paragraph 4.11.5; if wiring external parallel pull chain connections, proceed to paragraph 4.11.6; if wiring Minislot connections, proceed to paragraph 4.11.7; if wiring REPO connections, proceed to paragraph 4.12; otherwise, proceed to Step 13.
13. Reinstall all safety shield panels previously removed and secure with the retained hardware.
14. If removed, reinstall the sidecar front panel and secure with the retained hardware.
15. Close the UPS outside door and secure the latch.

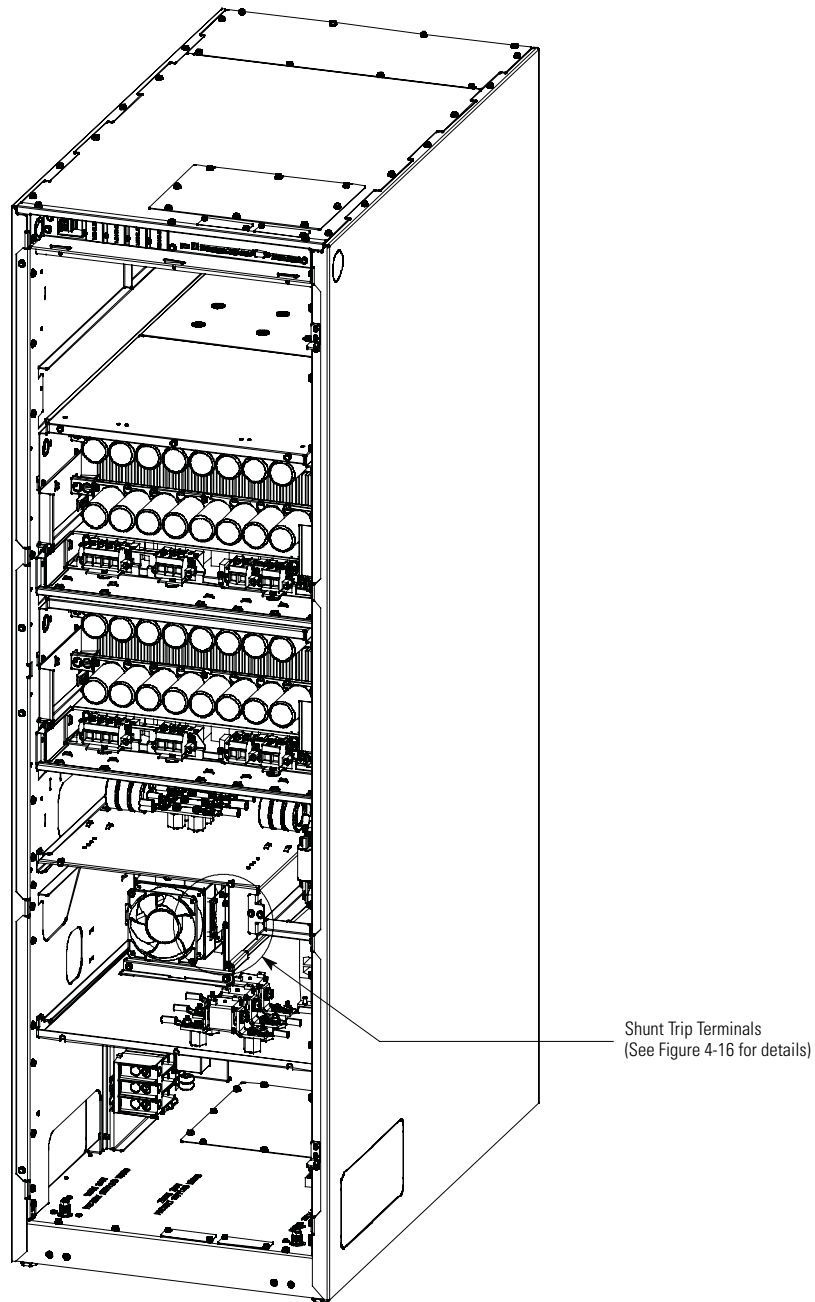

Figure 4-15. Battery Shunt Trip Location

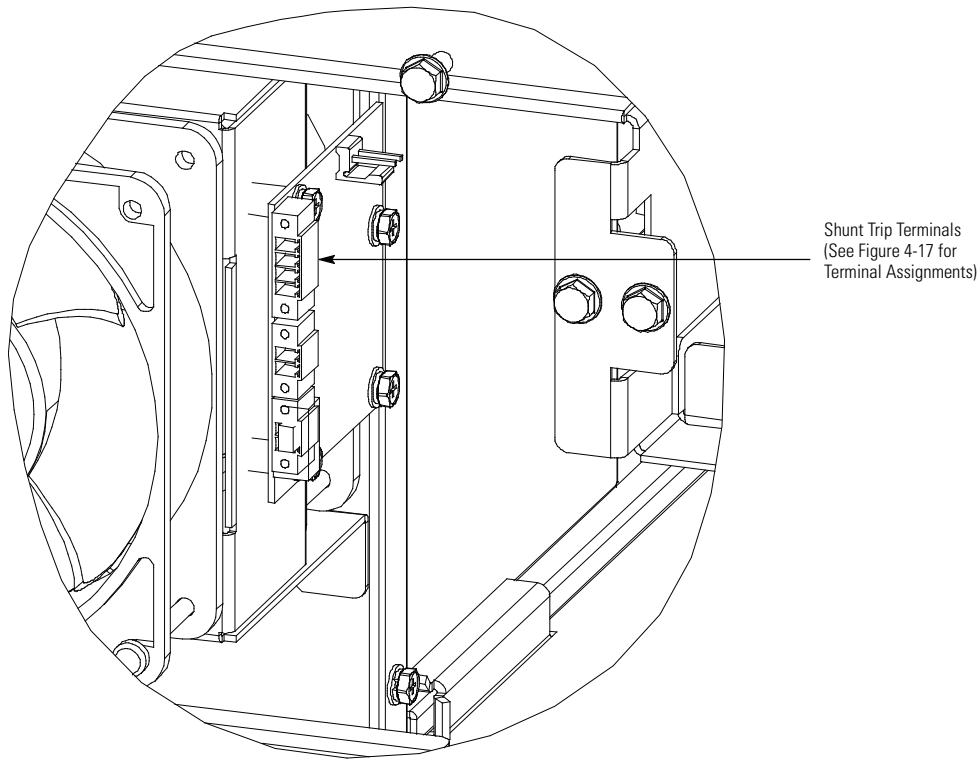

Figure 4-16. Battery Shunt Trip Terminal Detail

Table 4-3. Battery Shunt Trip Connections and Wire Terminations

Terminal	Name	Description	Recommended Minimum Wire Size	Size of Pressure Termination	Tightening Torque
1	48 Vdc Battery Shunt Trip +	Output: Contacts used to open battery breaker or disconnect	Twisted Pair Wires #18 AWG	#14–#30 AWG	2 lb in (0.22-0.25 Nm)
2	48 Vdc Battery Shunt Trip –				
3	Not Used				
4	Not Used				

**UPS
Shunt Trip
Terminals**

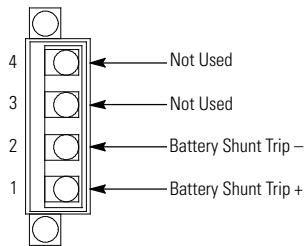

Figure 4-17. Battery Shunt Trip Terminal Assignments

4.11.4 Generator Interface Connections

If ESS is enabled and the UPS will be fed by a site generator at any time, the On Generator building alarm must be wired and configured to a Building Alarm Input. Wiring the On Generator sensing circuit to a building alarm allows the UPS to optimize its operation with the generator by transferring the UPS from ESS mode to Normal (double conversion) mode.

NOTE 1 An UPS building alarm input is used to indicate On Generator.

NOTE 2 Any pair of unused building alarm terminals may be used for On Generator connections.



NOTE 3 Program the building alarm to read On Generator and for either Normally Open (default) or Normally Closed as required by the generator sensing output.

NOTE 4 If installing interface wiring connections between standalone cabinets, conduit must be installed between cabinets.

NOTE 5 Disconnect terminal block plugs from terminal blocks to wire plugs.

To Install wiring:

1. Verify the UPS system is turned off and all power sources are removed. See Chapter 6, “UPS Operating Instructions,” for shutdown instructions.
2. If not already opened, open the front door by lifting the latch from the bottom and turning to the right (counterclockwise) and swing the door open.
3. If wiring the interface terminals from the bottom of the UPS, proceed to Step 8; otherwise, proceed to Step 4.
4. **Top Entry Wiring.** Remove the top interface entry conduit landing plates to drill or punch holes (see Figure 4-4).
5. Reinstall the interface entry plates and install the conduit.
6. Route the UPS building alarm interface wiring through the top interface entry conduit landing plates to the UPS building alarm terminals. See Figure 4-4 for wiring access information and Figure 4-9 and Figure 4-10 for UPS interface terminal locations.
7. Proceed to Step 13.
8. **Bottom Entry Wiring.** Remove the bottom interface entry conduit landing plates to drill or punch holes (see Figure 4-11).
9. Reinstall the interface entry plates and install the conduit.
10. Route the UPS building alarm interface wiring through the bottom interface entry conduit landing plates to the bottom access interface wiring channel along the inside of the front door (see Figure 4-11).
11. Route the wiring along the interface wiring channel (see Figure 4-11) to the UPS building alarm terminals. See Figure 4-9 and Figure 4-10 for UPS interface terminal locations.
12. Secure the wiring to the wire tie anchors provided (see Figure 4-12) using Zip ties.
13. Connect the building alarm interface wiring to the building alarm terminals. See paragraph 3.2.4 and Table 4-1 for wiring and termination requirements, and Figure 4-13 for terminal assignments.
14. If wiring external parallel CAN connections, proceed to paragraph 4.11.5; if wiring external parallel pull chain connections, proceed to paragraph 4.11.6; if wiring Minislot connections, proceed to paragraph 4.11.7; if wiring REPO connections, proceed to paragraph 4.12; otherwise, proceed to Step 15.
15. Close the UPS outside door and secure the latch.

4.11.5 Installing External Parallel CAN Control Wiring and Connections



NOTE 6 If installing interface wiring connections between standalone cabinets, conduit must be installed between each cabinet.

NOTE 7 Disconnect terminal block plugs from terminal blocks to wire plugs.

To install wiring:

1. Verify the UPS system is turned off and all power sources are removed. See Chapter 6, “UPS Operating Instructions,” for shutdown instructions.
2. If not already opened, open the front door by lifting the latch from the bottom and turning to the right (counterclockwise) and swing the door open.
3. If wiring the external parallel CAN connections using the inter-cabinet wiring access pass-through (line-up-and-match configurations), proceed to Step 4; if wiring the external parallel CAN connections using bottom entry access, proceed to Step 6; if wiring the external parallel CAN connections using top entry access, proceed to Step 12.
4. **Pass-through Wiring.** Route the external parallel CAN control wiring between UPS cabinets through the top UPS inter-cabinet wiring access pass-through to the UPS external parallel terminals. See Figure 4-6 for UPS wiring access information, and Figure 4-9 and Figure 4-10 for UPS interface terminal locations.
5. Proceed to Step 15.
6. **Bottom Entry Wiring.** Remove the bottom interface entry conduit landing plate to drill or punch holes (see Figure 4-11).
7. Reinstall the interface entry plate and install the conduit.
8. Route the external parallel CAN control wiring through the bottom interface entry conduit landing plate to the bottom access interface wiring channel along the inside of the front door (see Figure 4-11).
9. Route the wiring along the interface wiring channel (see Figure 4-11) to the UPS external parallel terminals. See Figure 4-9 and Figure 4-10 for UPS interface terminal locations.
10. Secure the wiring to the wire tie anchors provided (see Figure 4-12) using Zip ties.
11. Proceed to Step 15.
12. **Top Entry Wiring.** Remove the top interface entry conduit landing plate to drill or punch holes (see Figure 4-4).
13. Reinstall the interface entry plate and install the conduit.
14. Route the external parallel CAN control wiring through the top interface entry conduit landing plate to the UPS external parallel terminals. See Figure 4-4 for wiring access information and Figure 4-9 and Figure 4-10 for UPS interface terminal locations.
15. Connect the external parallel CAN wiring to the CAN terminals. See paragraph 3.2.4, Table 4-4, and Table 4-5 for wiring and termination requirements, and Figure 4-18 and Figure 4-19 for wiring information and terminal assignments.
16. If wiring external parallel pull chain connections, proceed to paragraph 4.11.6; if wiring Minislot connections, proceed to paragraph 4.11.7; if wiring REPO connections, proceed to paragraph 4.12; otherwise, proceed to Step 17.
17. Close the UPS outside door and secure the latch.

Table 4-4. External Parallel CAN and Pull Chain Connections

External Parallel Terminal Block	Name	Description
1	Pull Chain	External parallel pull chain connections between UPSs.
2	Pull Chain Ground	
3	CAN H In	External parallel CAN input connections from previous UPS.
4	CAN L In	
5	Ground	
6	Earth	Not Used
7	CAN H Out	External parallel CAN output connections to next UPS.
8	CAN L Out	
9	Ground	
10	Earth	Not Used

Table 4-5. External Parallel CAN and Pull Chain Terminal Block Terminations

Terminal Function	Size of Pressure Termination	Tightening Torque Nm (lb in)	Type Screw	Comments
CAN	#26–#16	0.4 (3.5) - 0.8 (7.1)	Slotted	Use shielded twisted-pair wires with drain wire for each input and return or common. Strip wire insulation back 10 millimeters to wire terminal blocks.
Pull Chain	#26–#16	0.4 (3.5) - 0.8 (7.1)	Slotted	Use twisted-pair wires for each input and return or common. Strip wire insulation back 10 millimeters to wire terminal blocks.

UPS System Installation

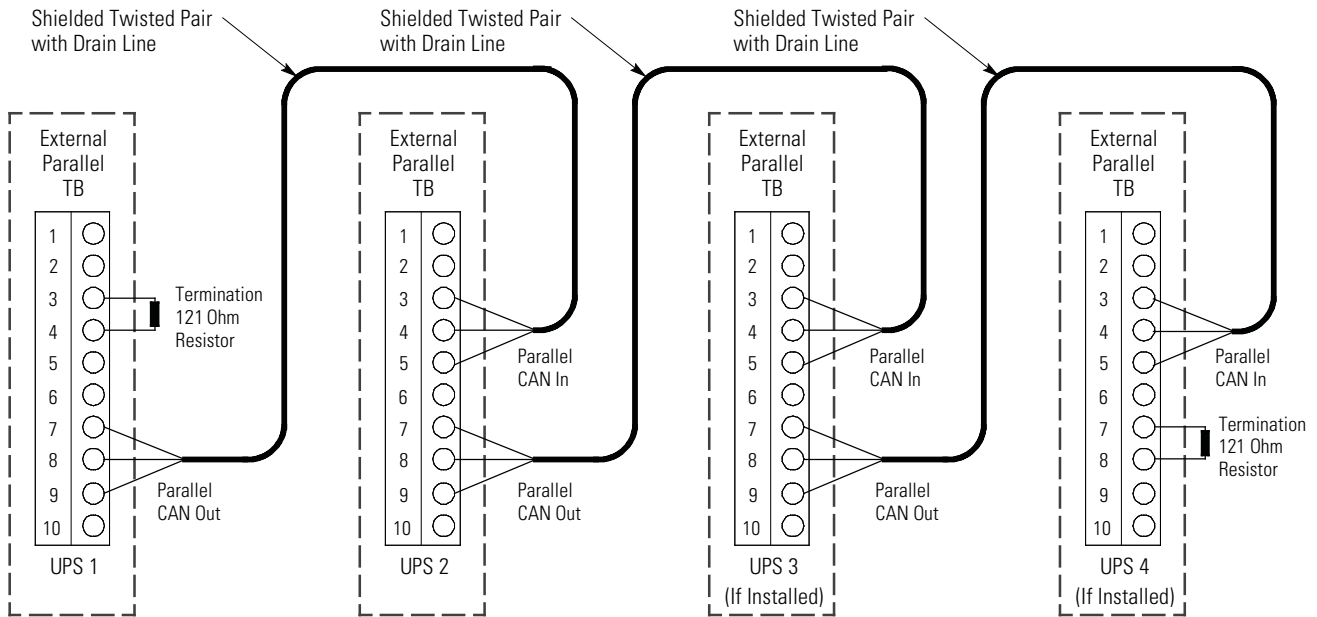

NOTE 1 External parallel CAN connections between UPS cabinets require shielded twisted pair wire with drain wire.

NOTE 2 Terminations are 121 ohm 1% resistors installed in the terminal block in the first and last UPS.

Figure 4-18. External Parallel CAN Wiring

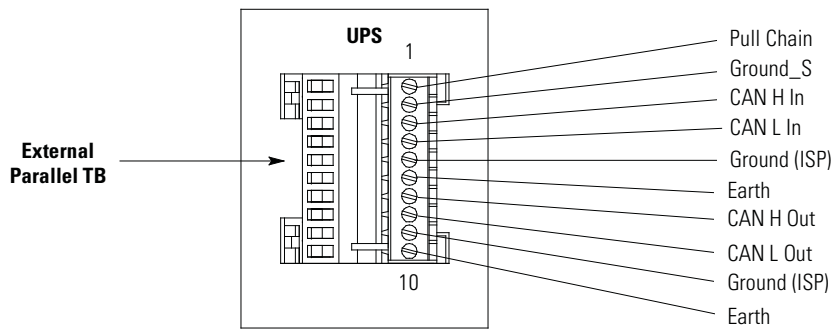

Figure 4-19. External Parallel Terminal Block

4.11.6 Installing External Parallel Pull Chain Control Wiring and Connections

NOTE 1 An UPS building alarm input is used to indicate an open MOB.

NOTE 2 Any pair of unused building alarm terminals may be used for the MOB Aux 1 connections.



NOTE 3 Program the MOB building alarm to read MOB open and for normally closed contacts.

NOTE 4 If installing interface wiring connections between standalone cabinets, conduit must be installed between cabinets.

NOTE 5 Disconnect terminal block plugs from terminal blocks to wire plugs.

To install wiring:

1. Verify the UPS system is turned off and all power sources are removed. See Chapter 6, “UPS Operating Instructions,” for shutdown instructions.
2. If not already opened, open the front door by lifting the latch from the bottom and turning to the right (counterclockwise) and swing the door open.
3. If wiring the external parallel pull chain connections using the inter-cabinet wiring access pass-through (line-up-and-match configurations), proceed to Step 4; if wiring the external parallel pull chain connections using bottom entry access, proceed to Step 6; if wiring the external parallel pull chain connections using top entry access, proceed to Step 12.
4. **Pass-through Wiring.** Route the external parallel pull chain control wiring between UPS cabinets through the top UPS inter-cabinet wiring access pass-through to the UPS external parallel terminals. See Figure 4-6 for UPS wiring access information, and Figure 4-9 and Figure 4-10 for UPS interface terminal locations.
5. Proceed to Step 15.
6. **Bottom Entry Wiring.** Remove the bottom interface entry conduit landing plate to drill or punch holes (see Figure 4-11).
7. Reinstall the interface entry plate and install the conduit.
8. Route the external parallel pull chain control wiring through the bottom interface entry conduit landing plate to the bottom access interface wiring channel along the inside of the front door (see Figure 4-11).
9. Route the wiring along the interface wiring channel (see Figure 4-11) to the UPS external parallel and building alarm terminals. See Figure 4-9 and Figure 4-10 for UPS interface terminal locations.
10. Secure the wiring to the wire tie anchors provided (see Figure 4-12) using Zip ties.
11. Proceed to Step 15.
12. **Top Entry Wiring.** Remove the top interface entry conduit landing plate to drill or punch holes (see Figure 4-4).
13. Reinstall the interface entry plate and install the conduit.

14. Route the external parallel pull chain control wiring through the top interface entry conduit landing plate to the UPS external parallel and building alarm terminals. See Figure 4-4 for wiring access information and Figure 4-9 and Figure 4-10 for UPS interface terminal locations.
15. Connect the external parallel pull chain wiring to the pull chain and building alarm terminals. See paragraph 3.2.4, Table 4-4, and Table 4-5 for external parallel terminal block wiring and termination requirements, and Figure 4-19 and Figure 4-20 for wiring information and terminal assignments. See Table 4-3 for building alarm wiring and termination requirements, and Figure 4-13 for terminal assignments.
16. If wiring Minislot connections, proceed to paragraph 4.11.7; if wiring REPO connections, proceed to paragraph 4.12; otherwise, proceed to Step 17.
17. Close the UPS outside door and secure the latch.

4.11.7 Installing Minislot Interface Connections

NOTE 1 LAN drop for use with Minislot cards must be provided by the customer.



NOTE 2 When installing interface wiring connections, conduit must be installed between each device and the UPS cabinet.

NOTE 3 Remove the cabinet stiffener bar (see Figure 4-10) before installing or removing Minislot cards. Reinstall the bar after the procedure is completed,

For installation and setup of a Minislot card, contact an Eaton service representative (see paragraph 1.9)

To install wiring:

1. If not already installed, install the LAN drop.
2. If not already opened, open the front door by lifting the latch from the bottom and turning to the right (counterclockwise) and swing the door open.
3. If wiring a Minislot card from the bottom of the UPS, proceed to Step 8; otherwise, proceed to Step 4.
4. Remove the top interface entry conduit landing plate to drill or punch holes (see Figure 4-4).
5. Reinstall the interface entry plate and install the conduit.
6. Route the Minislot card interface wiring through the top interface entry conduit landing plate to the Minislot card terminals. See Figure 4-4 for wiring access information, and Figure 4-9 and Figure 4-10 for Minislot card locations.
7. Proceed to Step 13.
8. Remove the bottom interface entry conduit landing plate to drill or punch holes (see Figure 4-11).
9. Reinstall the interface entry plate and install the conduit.
10. Route the Minislot card interface wiring through the bottom interface entry conduit landing plate to the bottom access interface wiring channel along the inside of the front door (see Figure 4-11).
11. Route the wiring along the interface wiring channel (see Figure 4-11) to the Minislot card terminals. See Figure 4-9 and Figure 4-10 for Minislot card locations.
12. Secure the wiring to the wire tie anchors provided (see Figure 4-12) using Zip ties.
13. Install the LAN and other cables to the appropriate Minislot cards. Refer to the manual supplied with the Minislot card for terminal assignments.
14. Refer to the manual supplied with the Minislot card for operator instructions.
15. If wiring REPO connections, proceed to paragraph 4.12; otherwise, proceed to Step 16.
16. Close the UPS outside door and secure the latch.

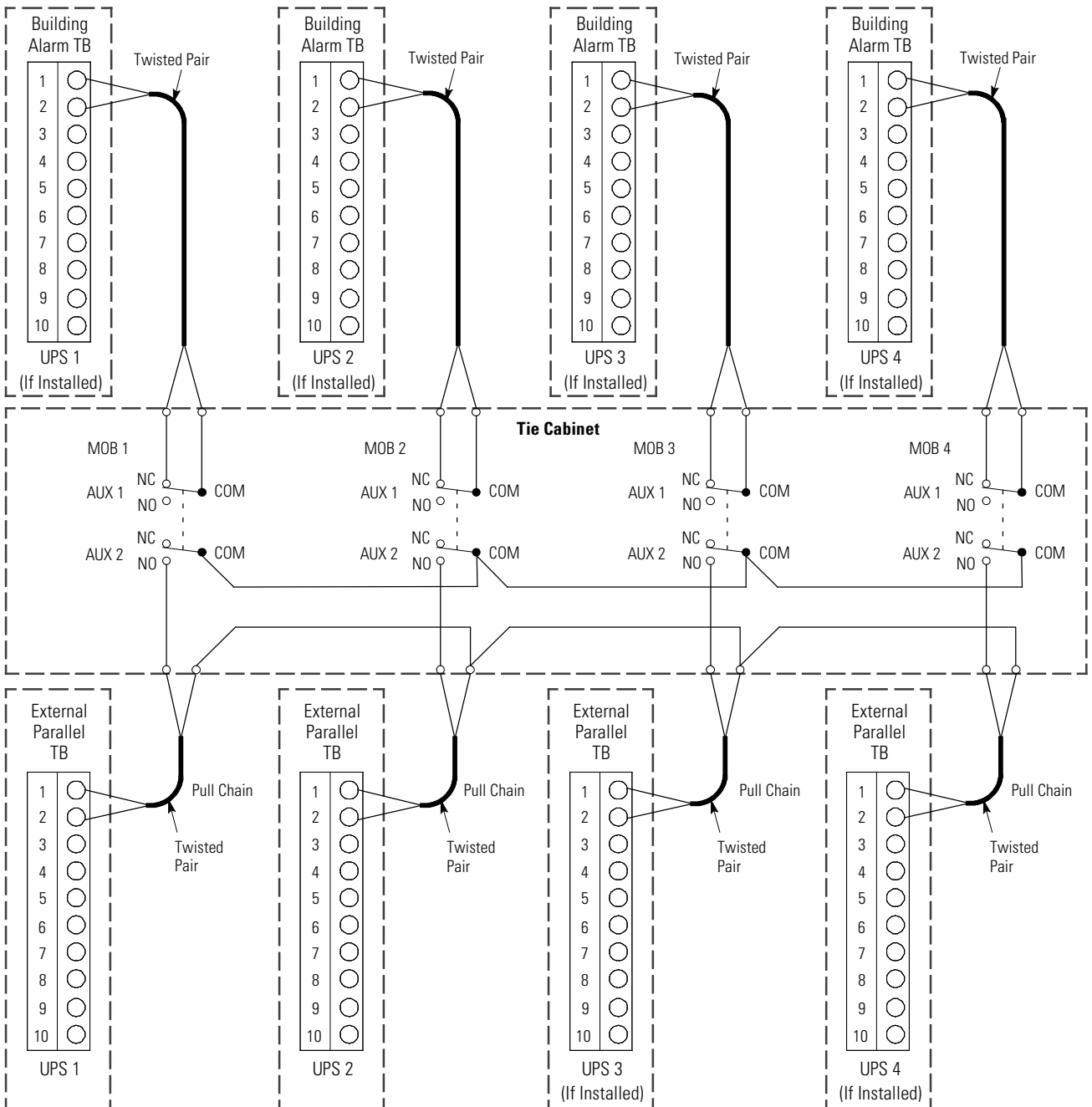

NOTE 1 External parallel pull chain connections between the UPS and MOB Aux contacts require twisted pair wire.

NOTE 2 NC and NO designations on MOB AUX contacts are defined with breaker in OFF (open) position.

NOTE 3 Always confirm contact operation prior to wiring.

NOTE 4 Any pair of unused building alarm terminals may be used for the MOB Aux 1 connections.

Figure 4-20. External Parallel Pull Chain Wiring

4.12 Installing a REPO Switch

A latching-type Remote Emergency Power-off (REPO) switch can be used in an emergency to shut down the UPS and remove power to the critical load from a location away from where the UPS is installed. Figure 4-21 shows a REPO switch.

NOTE 1 Before installing a REPO switch, verify that the UPS was installed according to the instructions in paragraphs 4.2 through 4.10.

NOTE 2 When installing the REPO switch, you must install conduit between the device and the UPS cabinet for wiring the switch.

NOTE 3 The REPO switch must be a normally-open or normally-closed latching-type switch not tied into any other circuits.



NOTE 4 This procedure is intended for installing the Eaton-supplied REPO switch. If installing another manufacturer's switch, use this procedure, and Figure 4-23 and Figure 4-24 as a guide.

NOTE 5 The REPO switch wiring must be in accordance with NEC Article 725 Class 2 requirements.

NOTE 6 Disconnect terminal block plugs from terminal blocks to wire plugs.

To Install a REPO switch:

1. Verify the UPS system is turned off and all power sources are removed. See Chapter 6, "UPS Operating Instructions," for shutdown instructions.
2. Securely mount the REPO switch. Recommended locations include operator's consoles or near exit doors. See Figure 3-8 for enclosure dimensions and wiring knockouts.
3. If not already opened, open the front door by lifting the latch from the bottom and turning to the right (counterclockwise) and swing the door open.
4. If wiring the REPO terminals from the bottom of the UPS, proceed to Step 9; otherwise, proceed to Step 5.
5. Remove the top interface entry conduit landing plate to drill or punch holes (see Figure 4-4).
6. Reinstall the interface entry plate and install the conduit.
7. Route the REPO wiring through the top interface entry conduit landing plate to the REPO terminals. See Figure 4-4 for wiring access information, and Figure 4-9 and Figure 4-10 for UPS interface terminal locations.
8. Proceed to Step 14.
9. Remove the bottom interface entry conduit landing plate to drill or punch holes (see Figure 4-11).
10. Reinstall the interface entry plate and install the conduit.

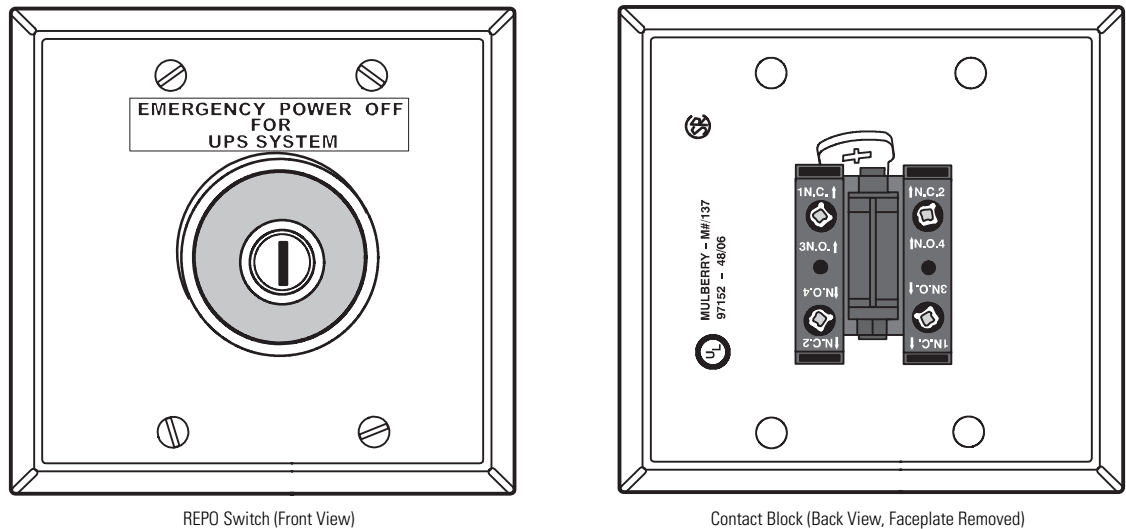

Figure 4-21. REPO Switch

11. Route the REPO wiring through the bottom interface entry conduit landing plate to the bottom access interface wiring channel along the inside of the front door (see Figure 4-11).
12. Route the wiring along the interface wiring channel (see Figure 4-11) to the REPO terminals. See Figure 4-9 and Figure 4-10 for UPS interface terminal locations.
13. Secure the wiring to the wire tie anchors provided (see Figure 4-12) using Zip ties.
14. Connect the REPO wiring as shown in Table 4-6 and Figure 4-23 for a normally-open REPO or Table 4-7 and Figure 4-24 for a normally-closed REPO. See paragraph 3.2.4 for wiring and termination requirements, and Figure 4-22 for terminal assignments.
15. If using a normally-closed REPO switch, connect a jumper wire between pins 3 and 4 on the REPO terminal block.
16. If you are installing multiple REPO switches, wire additional switches in parallel with the first REPO.
17. If required, install wiring from the REPO switch to the trip circuitry of the upstream protective devices. A second contact block is provided on the REPO switch for this function (see Figure 4-21). The REPO switch wiring must be in accordance with NEC Article 725 Class 2 requirements.
18. Close the UPS outside door and secure the latch.

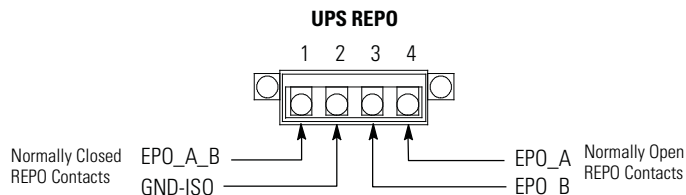
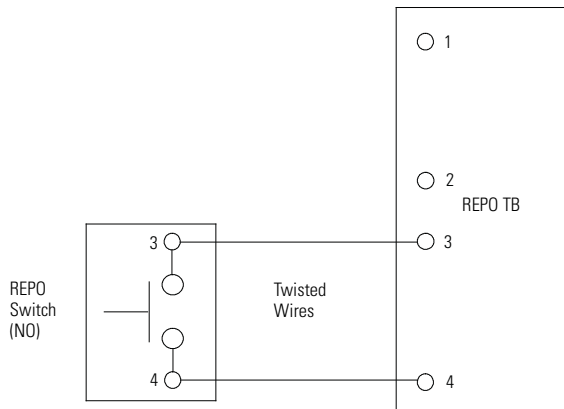

Figure 4-22. REPO Terminal Block Connector Assignments

Table 4-6. Normally-Open REPO Connections and Wire Terminations

From REPO Station Switch Contact Block (Either Block)	UPS REPO Terminal	Name	Description	Recommended Minimum Wire Size	Size of Wire Termination	Tightening Torque
3 NO	3	EPO_A	Input: normally-open dry contact used to activate UPS EPO from a remote switch.	Twisted Pair Wires #18 AWG	#16–#30 AWG	2 lb in (0.22-0.25 Nm)
4 NO	4	EPO_B				



NOTE REPO switch rating is 24 Vdc, 1A minimum.

NOTE The REPO switch must be a latching-type switch not tied to any other circuits.

Figure 4-23. Normally-Open REPO Switch Wiring

Table 4-7. Normally-Closed REPO Connections and Wire Terminations

From REPO Station Switch Contact Block (Either Block)	UPS REPO Terminal	Name	Description	Recommended Minimum Wire Size	Size of Wire Termination	Tightening Torque
3 NO	1	EPO_A_B	Input: normally-closed dry contact used to activate UPS EPO from a remote switch.	Twisted Pair Wires #18 AWG	#16–#30 AWG	2 lb in (0.22-0.25 Nm)
4 NO	2	GND-ISO				

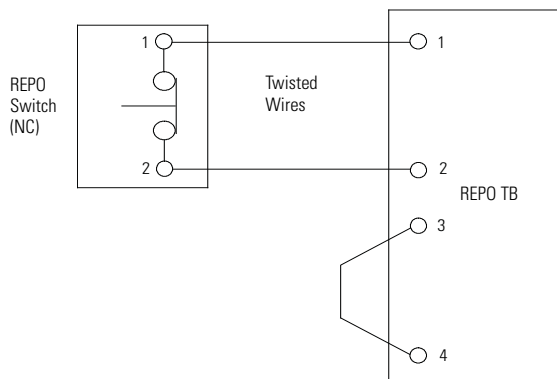

NOTE REPO switch rating is 24 Vdc, 1A minimum.

NOTE The REPO switch must be a latching-type switch not tied to any other circuits.

Figure 4-24. Normally-Closed REPO Switch Wiring

4.13 Initial Startup

Startup may be performed by the customer's battery qualified electrical contractor for single (not parallel) UPS installations without any accessory cabinets such as an External Battery Cabinet.

Startup and operational checks for parallel systems or installations with accessory cabinets must be performed by an authorized Eaton Customer Service Engineer, or the warranty terms specified on page W-1 become void. This service is offered as part of the sales contract for the UPS. Contact an Eaton service representative in advance (usually a two-week notice is required) to reserve a preferred startup date.

4.14 Completing the Installation Checklist

The final step in installing the UPS system is completing the following Installation Checklist. This checklist ensures that you have completely installed all hardware, cables, and other equipment. Complete all items listed on the checklist to ensure a smooth installation. Make a copy of the Installation Checklist before filling it out, and retain the original.

After the installation is complete, an Eaton Customer Service Engineer must verify the operation of the UPS system and commission it to support the critical load. The service representative cannot perform any installation tasks other than verifying software and operating setup parameters. Service personnel may request a copy of the completed Installation Checklist to verify all applicable equipment installations have been completed.

**NOTE**

The Installation Checklist **MUST** be completed prior to starting the UPS system for the first time.

Installation Checklist

- All packing materials and restraints have been removed from each cabinet.
- The UPS cabinet is placed in its installed location
- All conduits and cables are properly routed to the UPS and any ancillary cabinets.
- All power cables are properly sized and terminated.
- Battery cables are terminated on E4 (+) and E5 (–)
- Battery shunt trip signal wiring is connected from the UPS to the battery disconnect.
- Battery detect signal wiring is connected from the UPS to the battery disconnect.
- A ground conductor is properly installed.
- Building alarms and alarm relays are wired appropriately. (Optional)
- LAN drops are installed. (Optional)
- LAN connections have been completed. (Optional)
- The REPO device is mounted in its installed location and its wiring is terminated inside the UPS cabinet. (Optional)
- A jumper wire is connected between pins 3 and 4 on the REPO terminal block if using a normally-closed REPO switch. (Optional)
- All internal safety shields are installed.
- Accessories are mounted in installed locations and wiring is terminated inside the UPS cabinet. (Optional)
- Air conditioning equipment is installed and operating correctly.
- The area around the installed UPS system is clean and dust-free. (Eaton recommends that the UPS be installed on a level floor suitable for computer or electronic equipment.)
- Adequate workspace exists around the UPS and other cabinets.
- Adequate lighting is provided around all UPS equipment.
- A 120 Vac service outlet is located within 7.5 meters (25 feet) of the UPS equipment.
- Startup and operational checks are performed by an authorized Eaton Customer Service Engineer for parallel systems or installations with accessory cabinets.

This page intentionally left blank.

Section 2

Operation

Chapter 5 Understanding UPS Operation

5.1 UPS System Overview

The Eaton 93PM UPS is a continuous-duty, solid-state, transformerless, three-phase, true online system that provides conditioned and uninterruptible AC power to the UPS system's output and critical load.

The basic system consists of a rectifier, battery converter, inverter, monitoring/operation control panel, integrated communication server, and digital signal processor (DSP) logic. Figure 5-1 shows the main elements of the UPS system.

If utility power is interrupted or falls outside the parameters specified in Chapter 9, "Product Specifications," the UPS uses a backup battery supply to maintain power to the critical load for a specified period of time or until the utility power returns. For extended power outages, the UPS allows you to either transfer to an alternative power system (such as a generator) or shut down your critical load in an orderly manner.

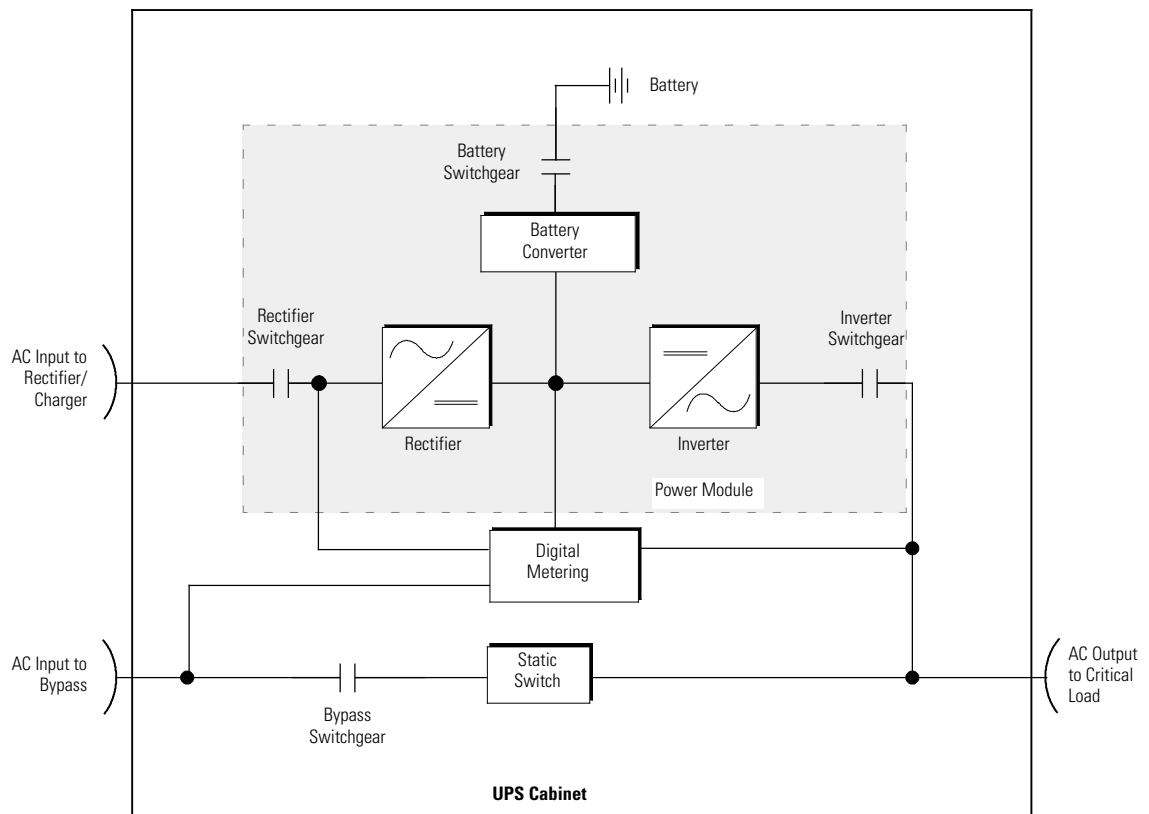

Figure 5-1. Main Elements of the UPS System

The emergency bypass consists of a continuous static switch, and bypass switchgear. The bypass switchgear is located in series with the static switch. The static switch is armed and ready during normal operation.

5.2 Single UPS

A single UPS operates independently to support an applied load from the inverter, providing conditioned and uninterruptible AC power to the critical load from the output of the module. During an outage, the inverter continues to operate, supporting power to the load from the battery supply. If the unit requires service, applied loads are transferred to the internal bypass either automatically or manually. With the exception of an optional external battery cabinet, no other cabinets or equipment are required for the single UPS to successfully support its applied loads.

5.2.1 Modes

The Eaton 93PMUPS supports a critical load in four different modes of operation:

- In Energy Saver System (ESS) mode, commercial AC power is supplied directly to the critical load through the internal bypass and transfers automatically to Normal mode (double-conversion on demand) if an abnormal condition is detected. The battery charger also provides charging current for the battery, if needed.
- In Normal (double-conversion) mode, the critical load is supplied by the inverter, which derives its power from rectified utility AC power. In this mode, the battery charger also provides charging current for the battery, if needed.
- In Bypass mode, the critical load is directly supported by utility power. The battery charger also provides charging current for the battery, if needed.
- In Battery mode, the battery provides DC power, which maintains inverter operation. The battery supports the critical load.

The following paragraphs describe the differences in the UPS operating modes, using block diagrams to show the power flow during each mode of operation.

5.2.2 Energy Saver System Mode

When the UPS is operating in ESS mode, commercial AC power is supplied directly to the critical load through the internal bypass with the power module in a standby state. Surge protection and some filtering is also provided, ensuring that clean power is delivered to the load equipment. If a commercial power brownout, blackout, overvoltage, undervoltage, out-of-tolerance frequency condition occurs, or any other disturbance is detected in the incoming power, the system forward transfers to normal mode (double-conversion on demand). In case of a complete utility outage or if input power is outside the tolerances of the system, the UPS transfers to battery mode and continues to supply conditioned, clean power to the critical load. When the input line returns to normal operating range, the UPS returns to ESS operation. For charging batteries, the UPS will not enter ESS mode until charger is 25% or less of maximum charger current.

When operating in ESS, the UPS superior detection and control algorithms continuously monitor incoming power quality and allow the fast engagement of power converters. Typical transition time to double conversion is less than two milliseconds, which is practically seamless. If the UPS detects a fault condition while operating in ESS, it is also able to detect and determine whether the fault is caused by the load or if it is upstream from the UPS. A fault at the bypass source results in an immediate switch over to the inverter; a fault in the load keeps the UPS in Energy Saver System (ESS) mode.

When power conditions are within acceptable limits, the UPS operates as a high-efficiency, energy-saving system — providing surge protection for IT equipment and ensuring clean power is delivered to the facility. Energy saver system increases system efficiency to 99% at 100% linear load and nominal V_{in} .

Figure 5-2 shows the path of electrical power through the UPS system when the UPS is operating in Normal mode.

ESS mode is a normal operating mode, and not an alarm condition. While the UPS is in this mode, the NORMAL light on the front display will illuminate.

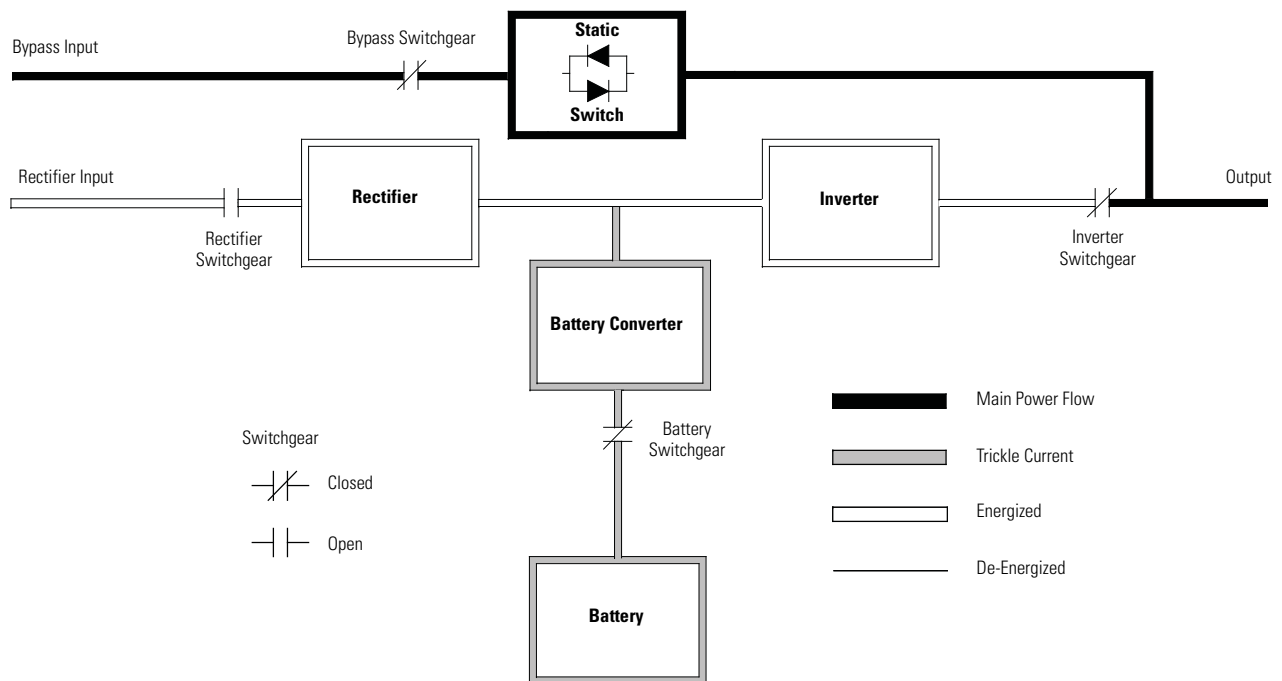

Figure 5-2. Path of Current Through the UPS in Energy Saver System Mode

5.2.3 Normal Mode

During Normal mode, power for the system is derived from a utility input source through the rectifier switchgear. Three-phase AC input power is converted to DC using IGBT devices to produce a regulated DC voltage to the inverter. When the battery switchgear is closed the battery is charged directly from the regulated rectifier output through a buck or boost DC converter, depending on the system voltage and the size of the battery string attached to the unit.

Figure 5-3 shows the path of electrical power through the UPS system when the UPS is operating in Normal mode.

The battery converter derives its input from the regulated DC output of the rectifier and provides a bucked regulated DC voltage charge current to the battery. The battery is always connected to the UPS and ready to support the inverter should the utility input become unavailable.

The inverter produces a three-phase AC output to a customer's load without the use of a transformer. The inverter derives regulated DC from the rectifier and uses IGBT devices and pulse-width modulation (PWM) to produce a regulated and filtered AC output. The AC output of the inverter is delivered to the system output through the inverter switchgear.

If the utility AC power is interrupted or is out of specification, the UPS automatically switches to Battery mode to support the critical load without interruption. When utility power returns, the UPS returns to Normal mode.

If the UPS becomes overloaded or unavailable, the UPS switches to Bypass mode. The UPS automatically returns to Normal mode when the overload condition is cleared and system operation is restored within specified limits.

If the UPS suffers an internal failure and is configured for capacity, it switches automatically to Bypass mode and remains in that mode until the failure is corrected and the UPS is back in service.

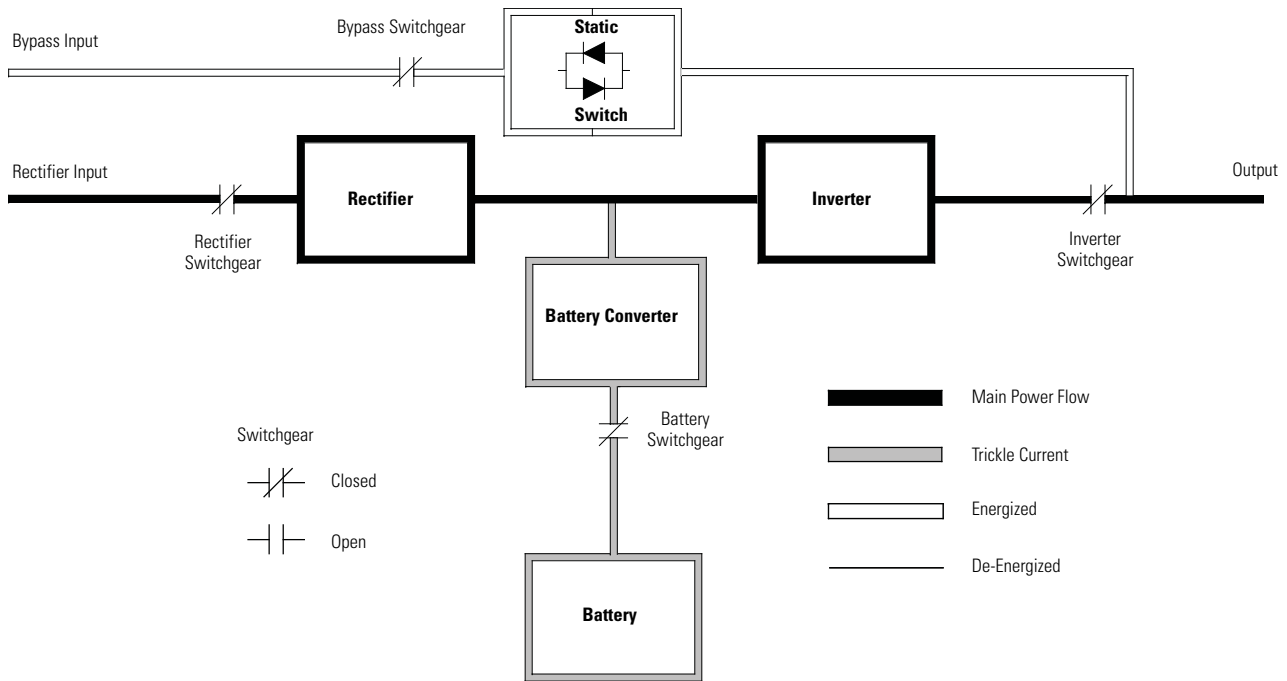

Figure 5-3. Path of Current Through the UPS in Normal Mode

5.2.4 Bypass Mode

⚠ CAUTION

The critical load is not protected from voltage or frequency fluctuations or power outages while the UPS is in Bypass mode.

The UPS automatically switches to Bypass mode if it detects an overload, load fault, or internal failure (if configured for capacity). If configured for redundancy (N+1) the UPS would remain on line in Normal mode if one UPM failed. The UPS can also be transferred from Normal mode to Bypass mode manually. The bypass source supplies the commercial AC power to the load directly. Figure 5-4 shows the path of electrical power through the UPS system when operating in Bypass mode.

In Bypass mode, the output of the system is provided with three-phase AC power directly from the system input. While in this mode, the output of the system is not protected from voltage or frequency fluctuations or power outages from the source. Some power line filtering and spike protection is provided to the load but no active power conditioning or battery support is available to the output of the system in the Bypass mode of operation.

The internal bypass is comprised of a solid-state, silicon-controlled rectifier (SCR) continuous static switch, and bypass switchgear. The static switch is used instantaneously anytime the inverter is unable to support the applied load. The continuous static switch is wired in series with the bypass switchgear, and together they are wired in parallel with the rectifier and inverter.

The static switch, being an electronically-controlled device, can be turned on immediately to pick up the load from the inverter while the inverter switchgear opens to isolate the inverter. The bypass switchgear is normally closed, ready to support the static switch unless the bypass input source becomes unavailable.

If the UPS transfers to Bypass mode from Normal mode due to any reason other than operator intervention, the UPS automatically attempts to transfer back to Normal mode (up to three times within a ten minute period). The fourth transfer locks the critical load to the bypass source and requires operator intervention to transfer.

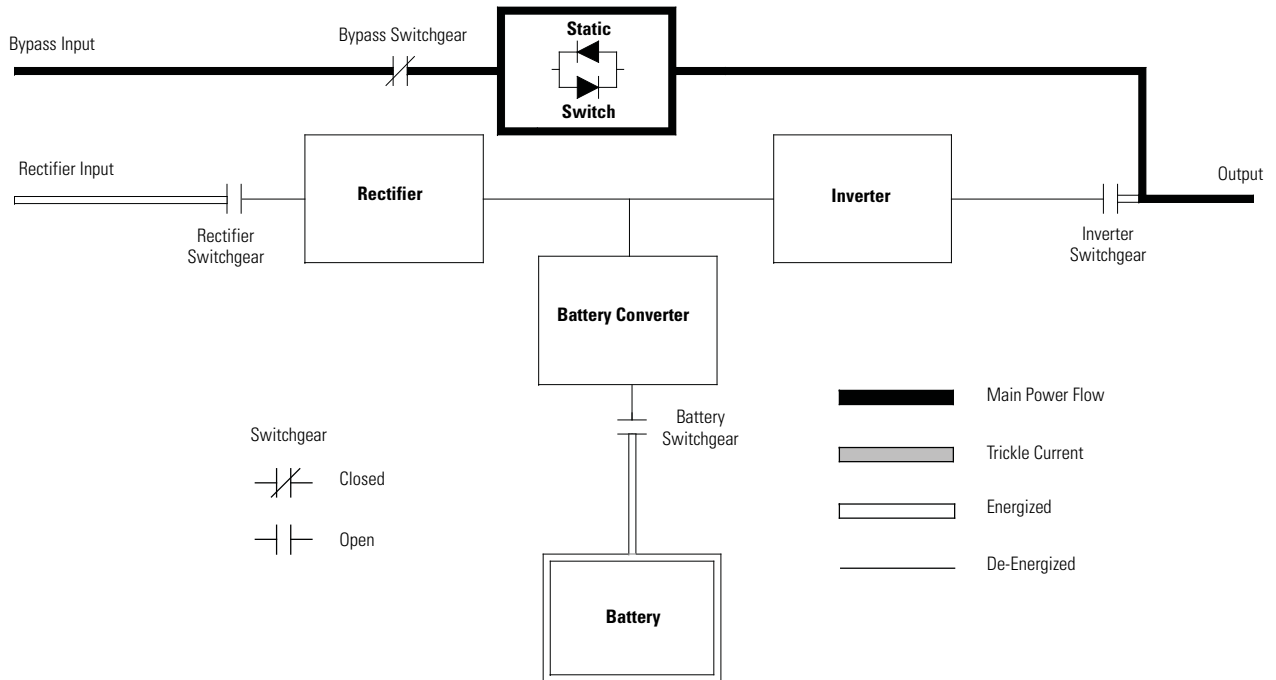

Figure 5-4. Path of Current Through the UPS in Bypass Mode

5.2.5 Battery Mode

The UPS automatically transfers to Battery mode if a utility power outage occurs, or if the utility power does not conform to specified parameters. In Battery mode, the battery provides emergency DC power that the inverter converts to AC power.

Figure 5-5 shows the path of electrical power through the UPS system when operating in Battery mode.

During a utility power failure, the rectifier no longer has an AC utility source from which to supply the DC output voltage required to support the inverter. The rectifier switchgear opens and the battery instantaneously supplies energy to the battery converter. The converter boosts the voltage so that the inverter can support the customer's load without interruption. If bypass is common with the rectifier input, the bypass switchgear also opens. The opening of the rectifier and bypass switchgear prevent system voltages from bleeding backwards through the static switch and rectifier snubber components to the utility source.

If the input power fails to return or is not within the acceptance windows required for normal operation, the battery continues discharging until a DC voltage level is reached where the inverter output can no longer support the connected loads. When this event occurs, the UPS issues another set of audible and visual alarms indicating SHUTDOWN IMMINENT. Unless the rectifier has a valid AC input soon, the output can be supported for only two minutes before the output of the system shuts down. If the bypass source is available, the UPS transfers to bypass instead of shutting down.

If at any time during the battery discharge the input power becomes available again, the rectifier and the bypass switchgear close and the rectifier begins to supply DC current to the converter and inverter. At this point, the unit returns to Normal mode. Depending on the total load and the duration of the battery discharge, battery current limit alarms may be seen for a short time due to the current required to recharge the battery.

Understanding UPS Operation

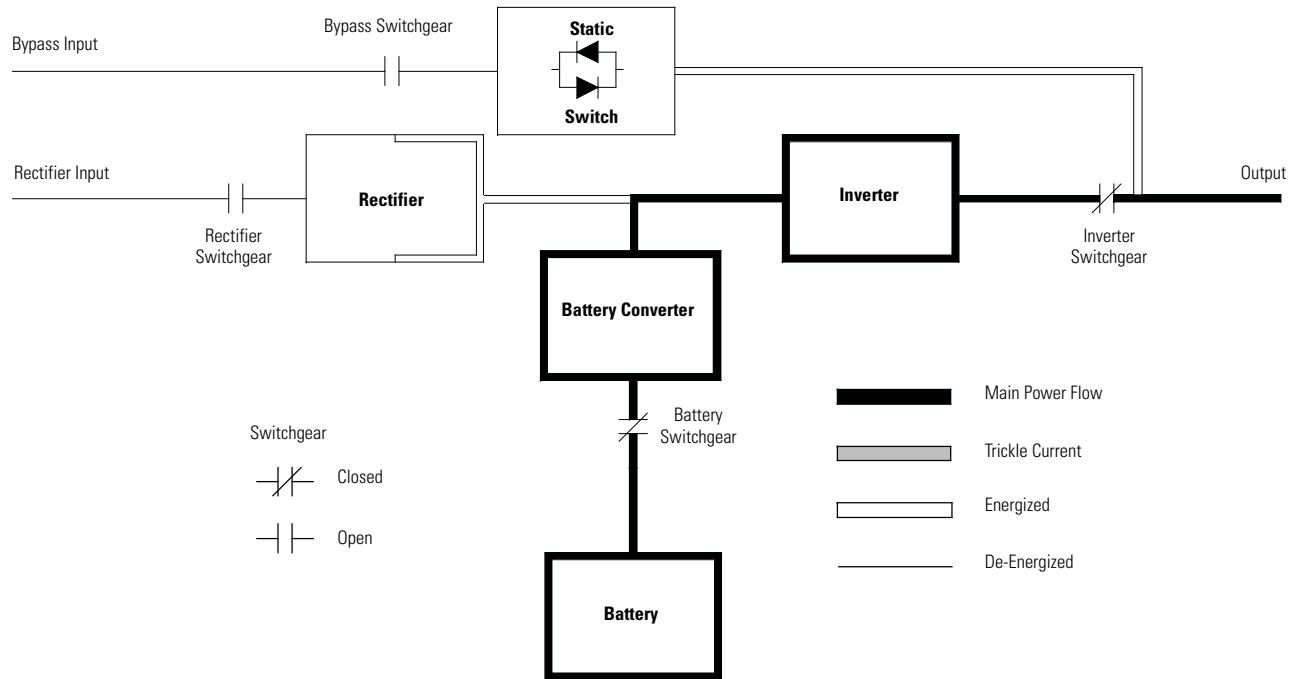

Figure 5-5. Path of Current Through the UPS in Battery Mode

5.3 Single UPS Unit System Online Configurations

The system online drawings in this section show the simplified internal structure of the UPS, battery supply, and basic maintenance bypass.

Online Drawing	UPS Model	Voltage		System Type
		Input	Output	
See Figure 5-6	93PM-100-1	480	480	Single one UPM reverse transfer UPS with external battery
See Figure 5-7	93PM-100-1	480	480	Single one UPM reverse transfer UPS with two breaker bypass and external battery
See Figure 5-8	93PM-100-1	480	480	Single one UPM reverse transfer UPS with three breaker bypass and external battery
See Figure 5-9	93PM-100-1	480	480	Single one UPM reverse transfer UPS with four breaker bypass and external battery
See Figure 5-10	93PM-100-2	480	480	Single two UPM reverse transfer UPS with external battery
See Figure 5-11	93PM-100-2	480	480	Single two UPM reverse transfer UPS with two breaker bypass and external battery
See Figure 5-12	93PM-100-2	480	480	Single two UPM reverse transfer UPS with three breaker bypass and external battery
See Figure 5-13	93PM-100-2	480	480	Single two UPM reverse transfer UPS with four breaker bypass and external battery
See Figure 5-14	93PM-100-3	480	480	Single three UPM reverse transfer UPS with external battery
See Figure 5-15	93PM-100-3	480	480	Single three UPM reverse transfer UPS with two breaker bypass and external battery
See Figure 5-16	93PM-100-3	480	480	Single three UPM reverse transfer UPS with three breaker bypass and external battery
See Figure 5-17	93PM-100-3	480	480	Single three UPM reverse transfer UPS with four breaker bypass and external battery

Understanding UPS Operation

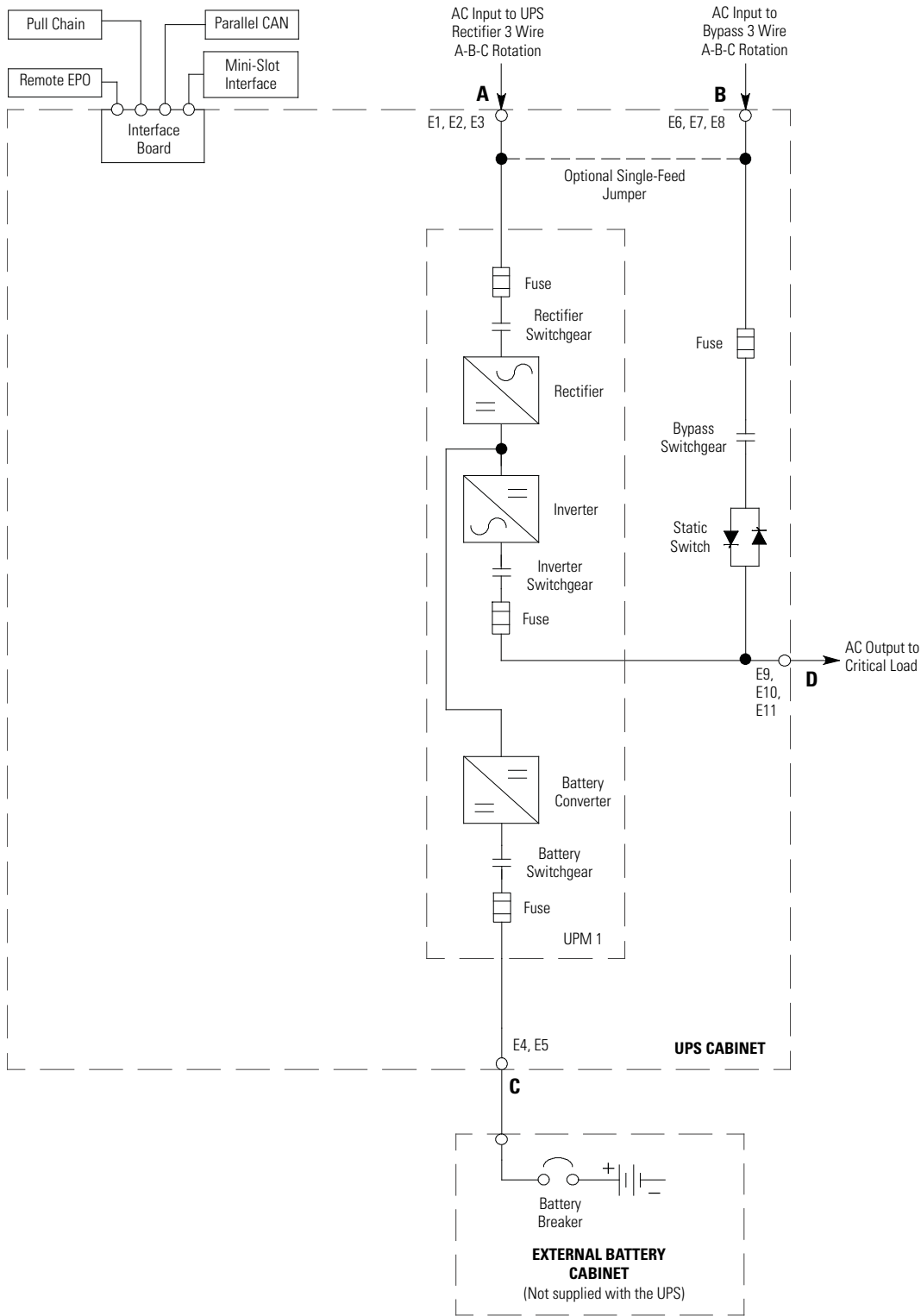

NOTE Callout letters **A**, **B**, **C**, and **D** map to Table 3-4.

Figure 5-6. Eaton 93PM-100-1 UPS System Oneline

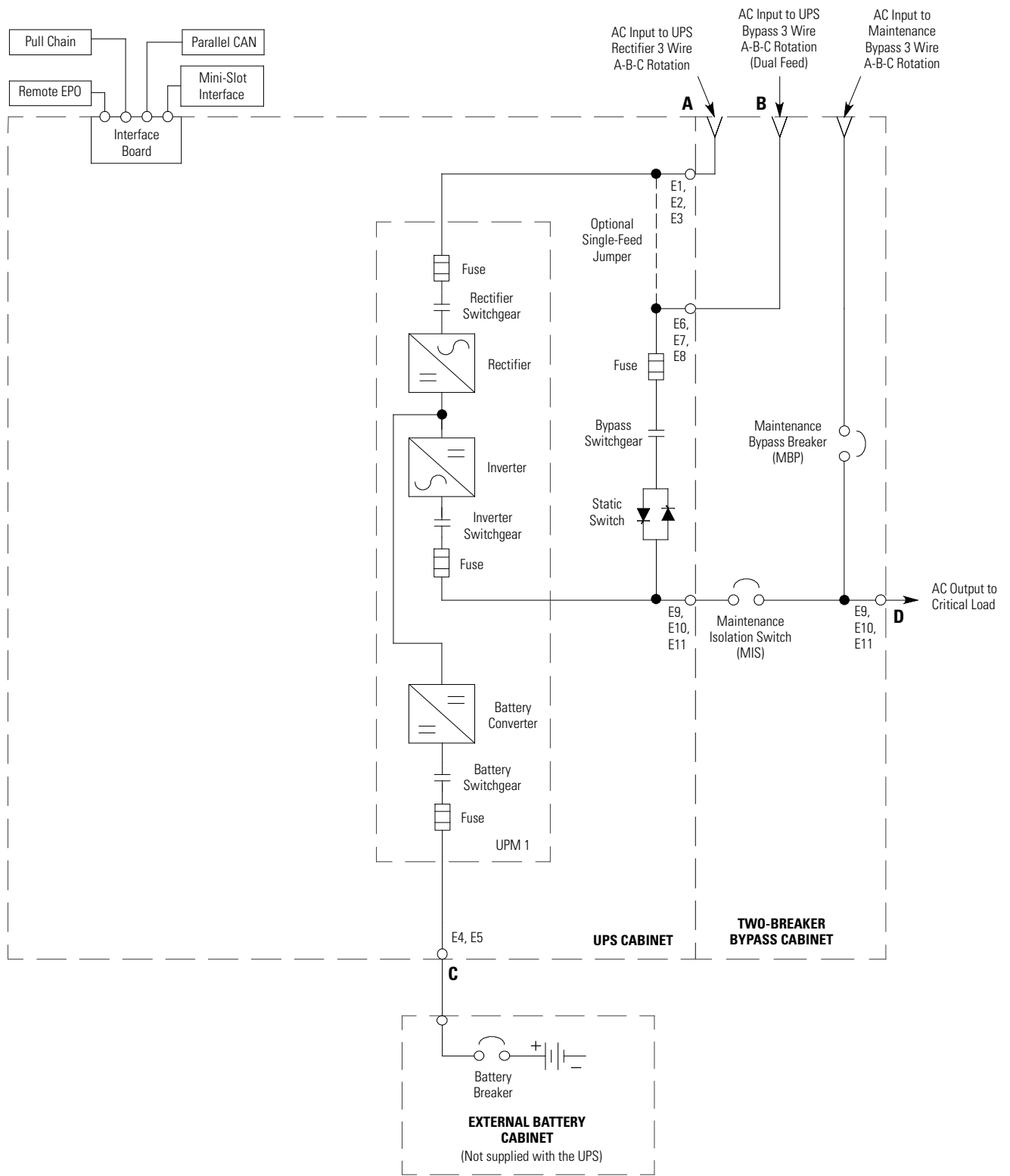

NOTE Callout letters A, B, C, and D map to Table 3-4.

Figure 5-7. Eaton 93PM-100-1 UPS System with Two-Breaker Bypass Online

Understanding UPS Operation

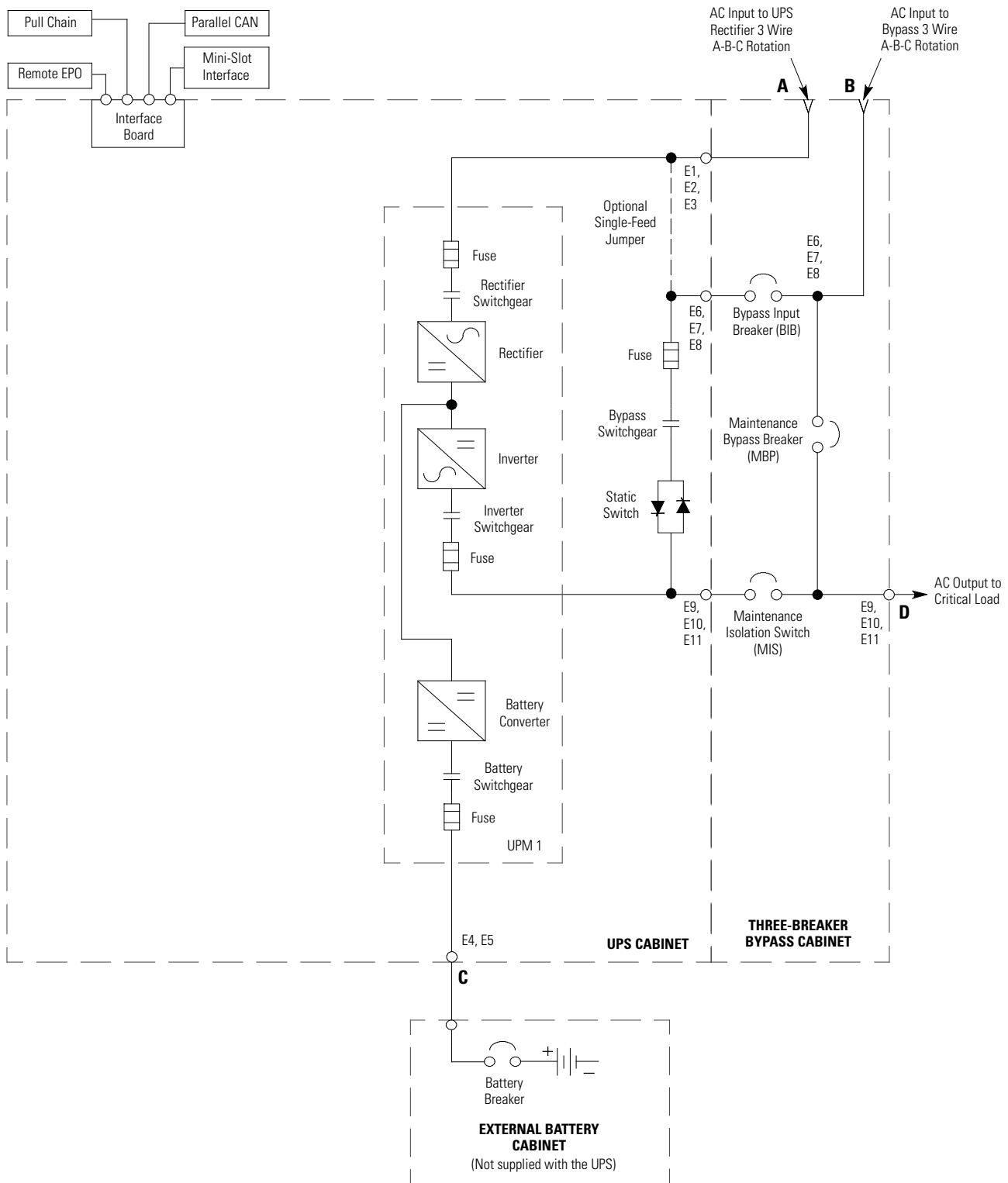

NOTE Callout letters **A, B, C, and D** map to Table 3-4.

Figure 5-8. Eaton 93PM-100-1 UPS System with Three-Breaker Bypass Online

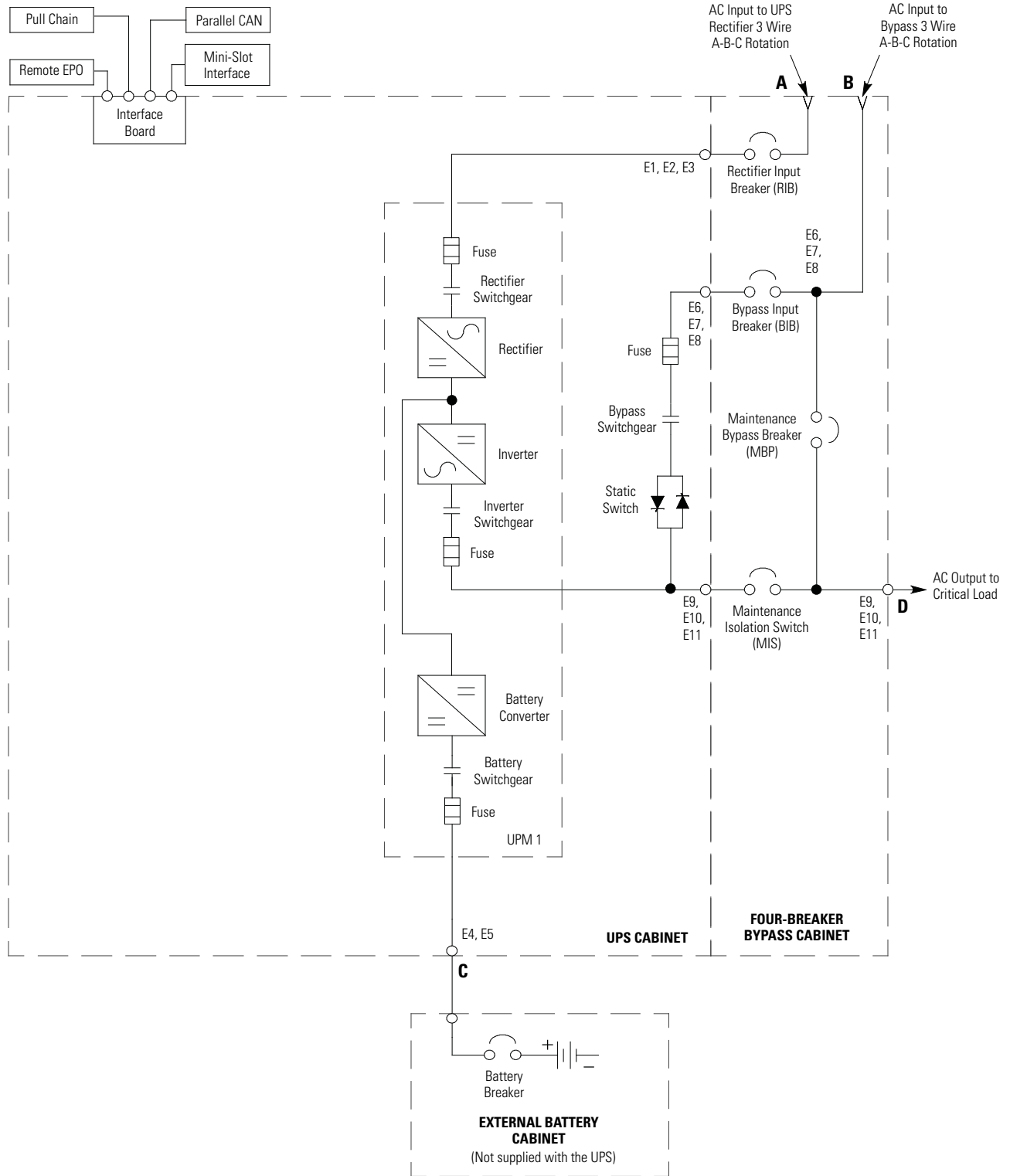

NOTE Callout letters **A, B, C, and D** map to Table 3-4.

Figure 5-9. Eaton 93PM-100-1 UPS System with Four-Breaker Bypass Online

Understanding UPS Operation

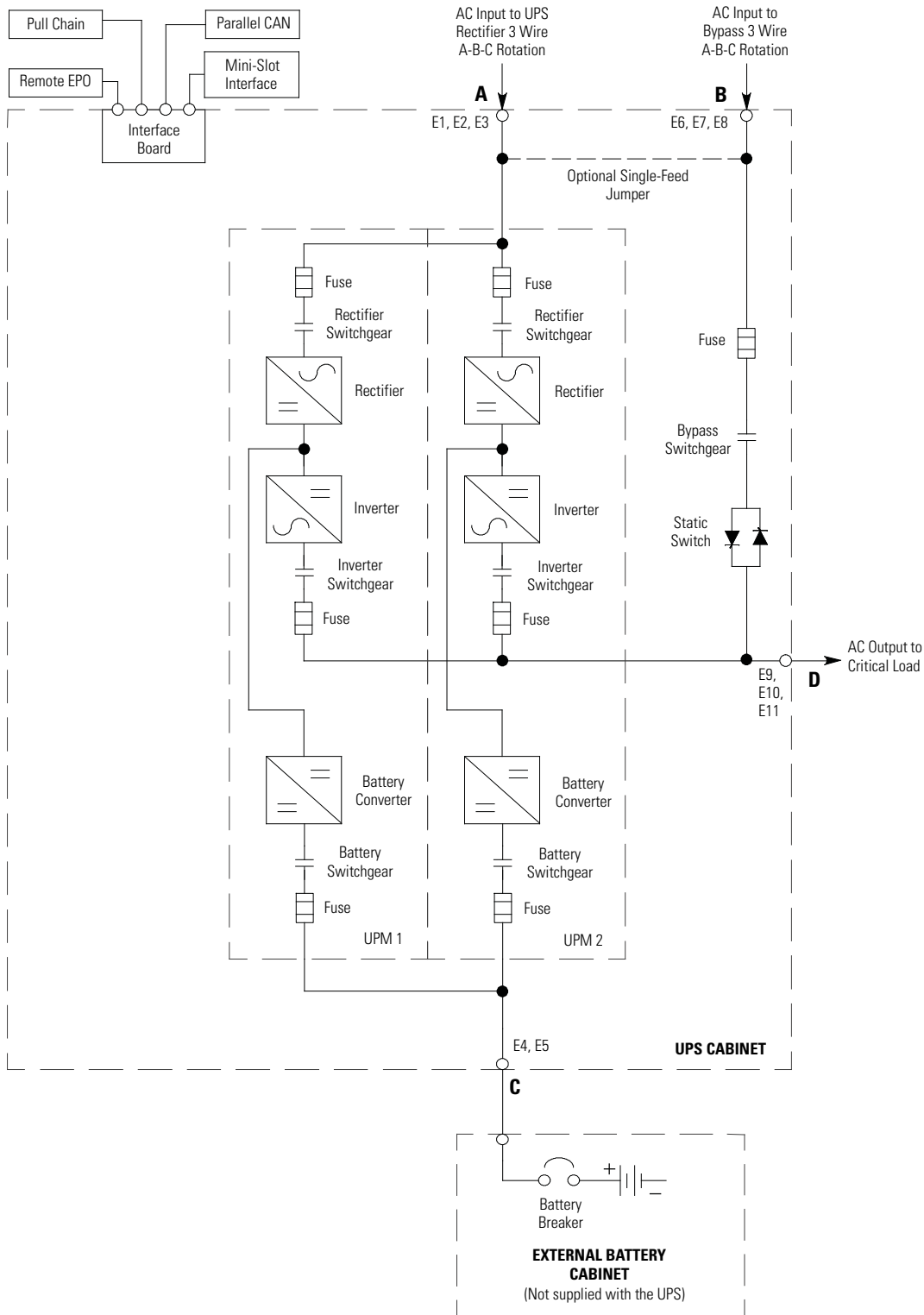

NOTE Callout letters **A, B, C, and D** map to Table 3-4 or Table 3-5.

Figure 5-10. Eaton 93PM-100-2 UPS System Online

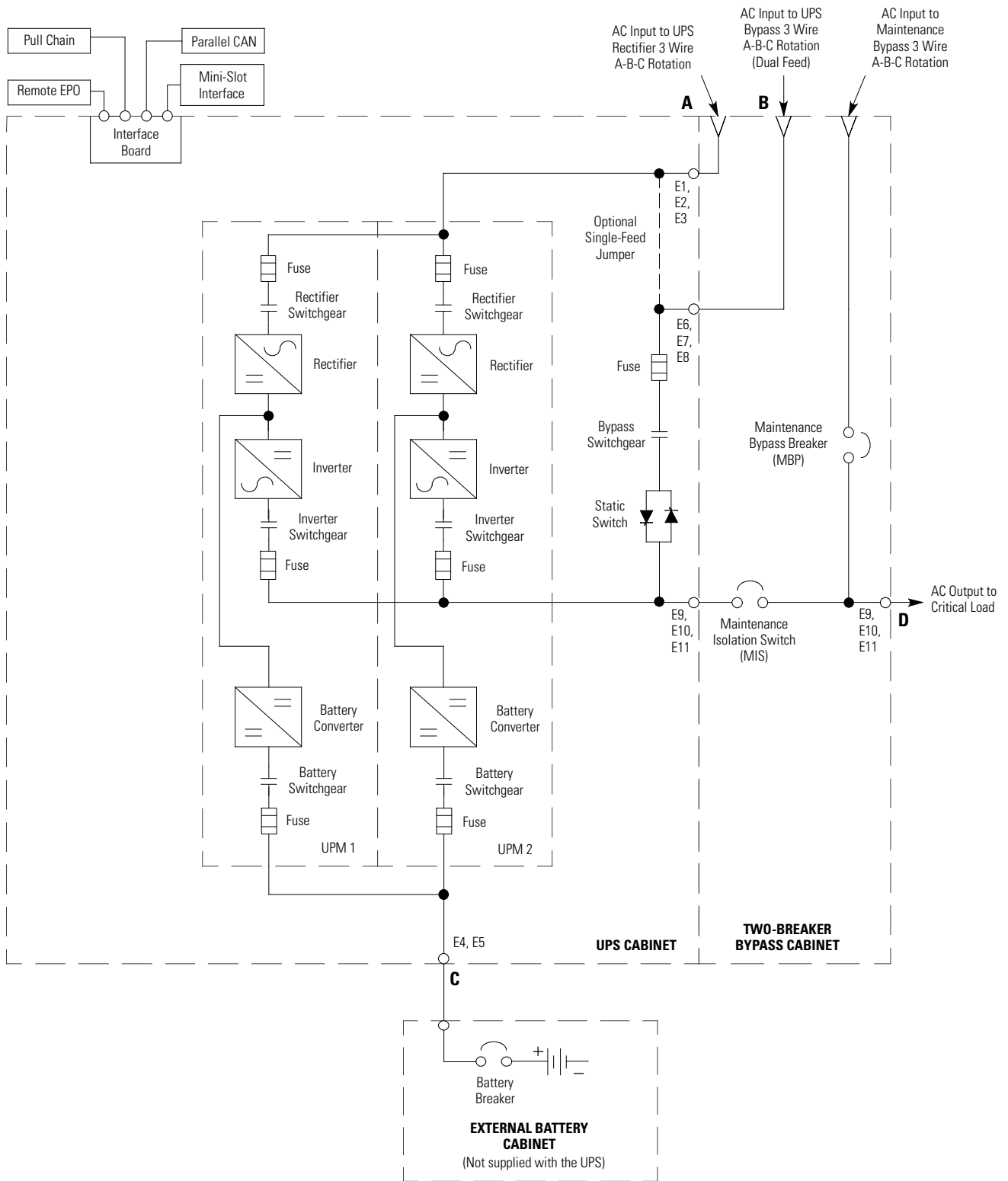
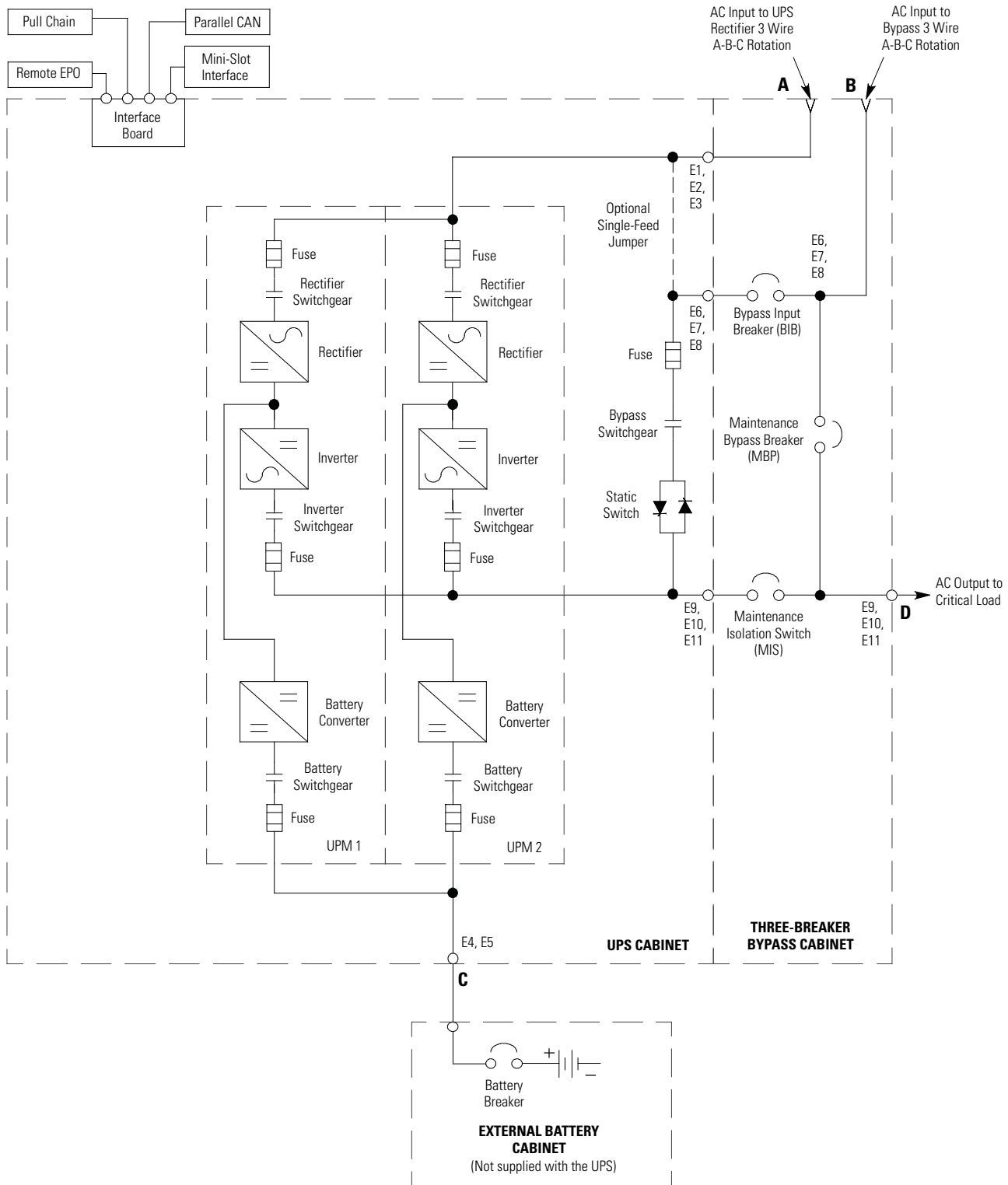

Figure 5-11. Eaton 93PM-100-2 UPS System with Two-Breaker Bypass Online

Understanding UPS Operation



NOTE Callout letters **A**, **B**, **C**, and **D** map to Table 3-4 or Table 3-5.

Figure 5-12. Eaton 93PM-100-2 UPS System with Three-Breaker Bypass Online

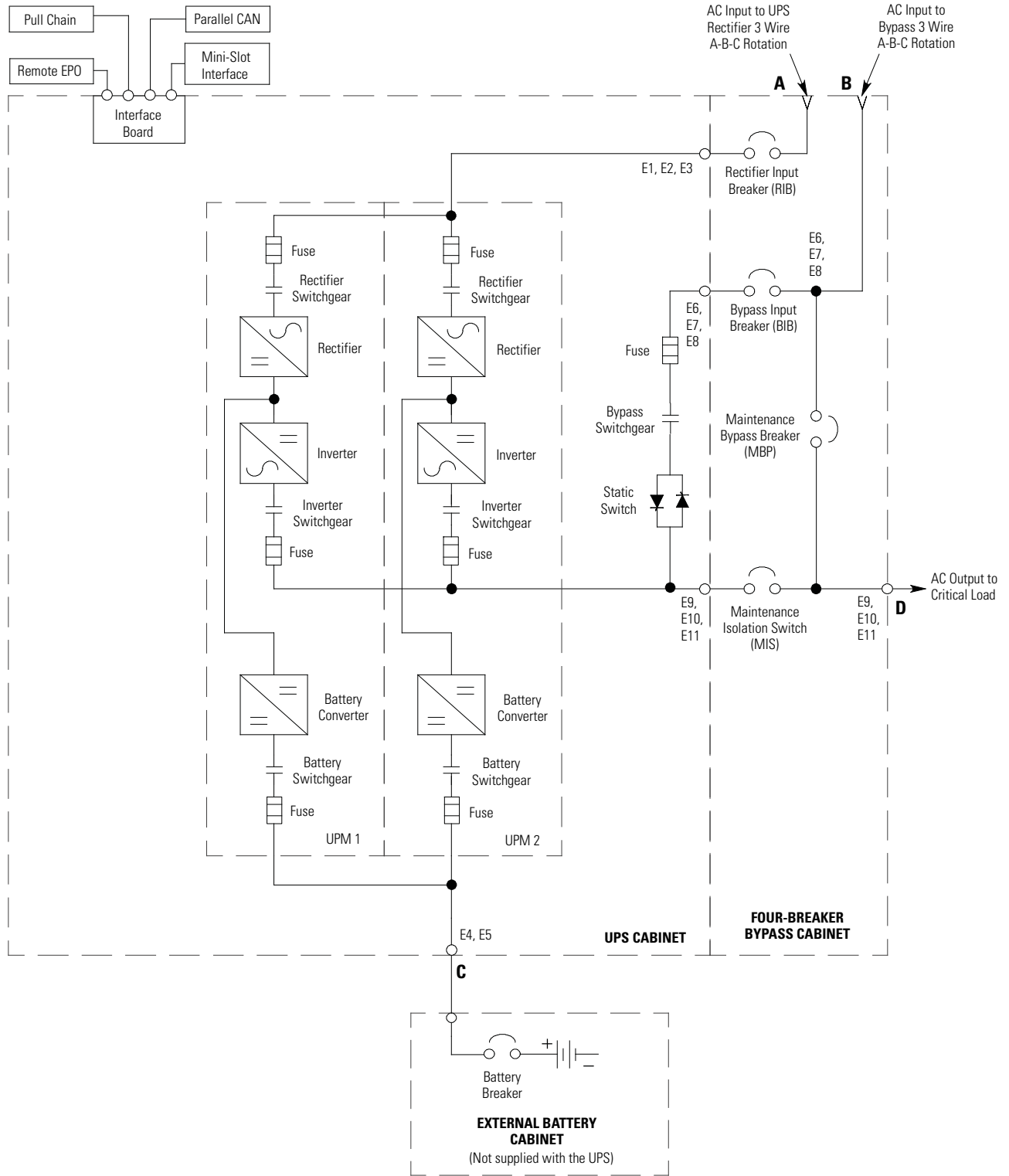

NOTE Callout letters **A, B, C, and D** map to Table 3-4 or Table 3-5.

Figure 5-13. Eaton 93PM-100-2 UPS System with Four-Breaker Bypass Online

Understanding UPS Operation

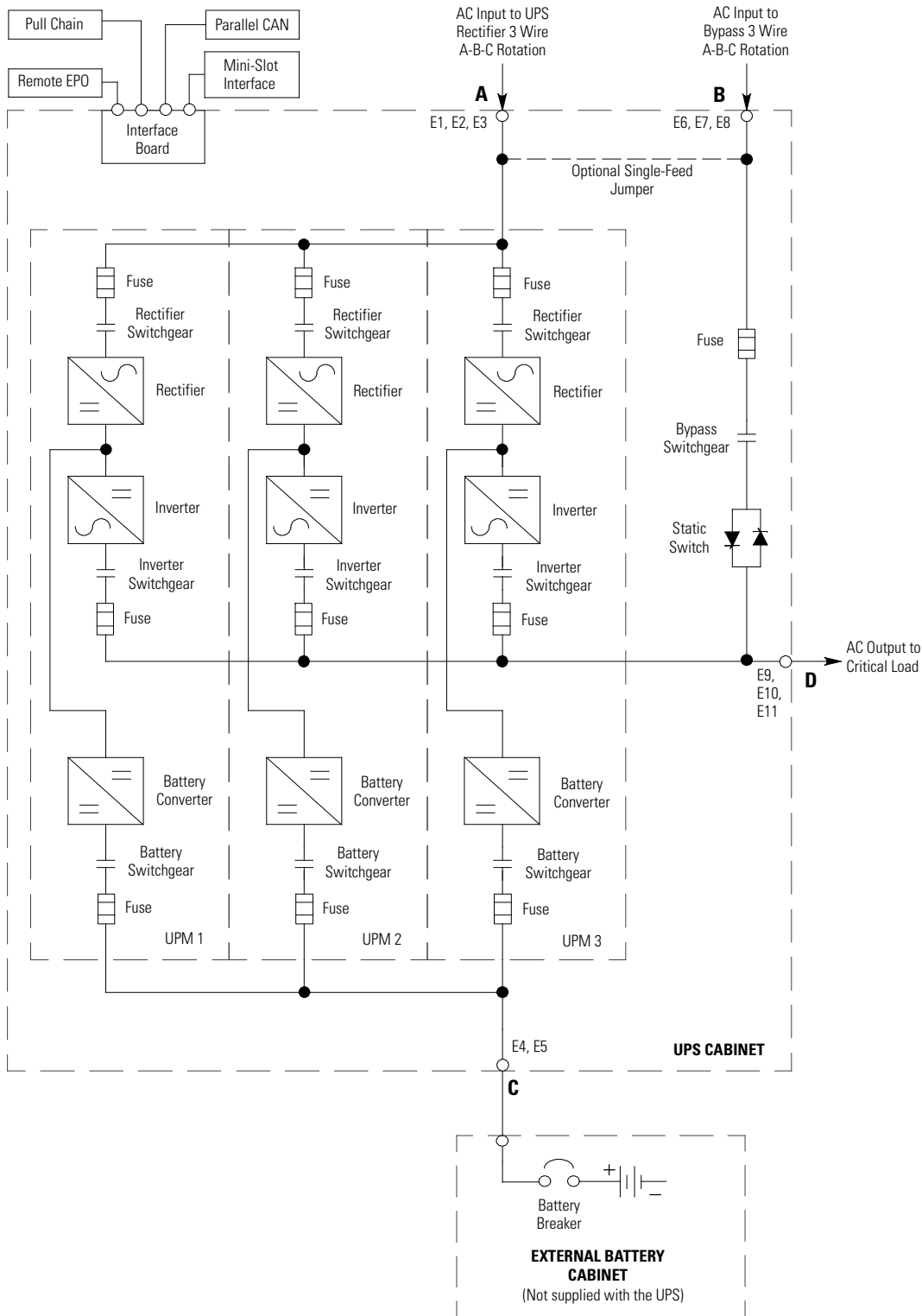

NOTE Callout letters **A**, **B**, **C**, and **D** map to Table 3-5.

Figure 5-14. Eaton 93PM-100-3 UPS System Oneline

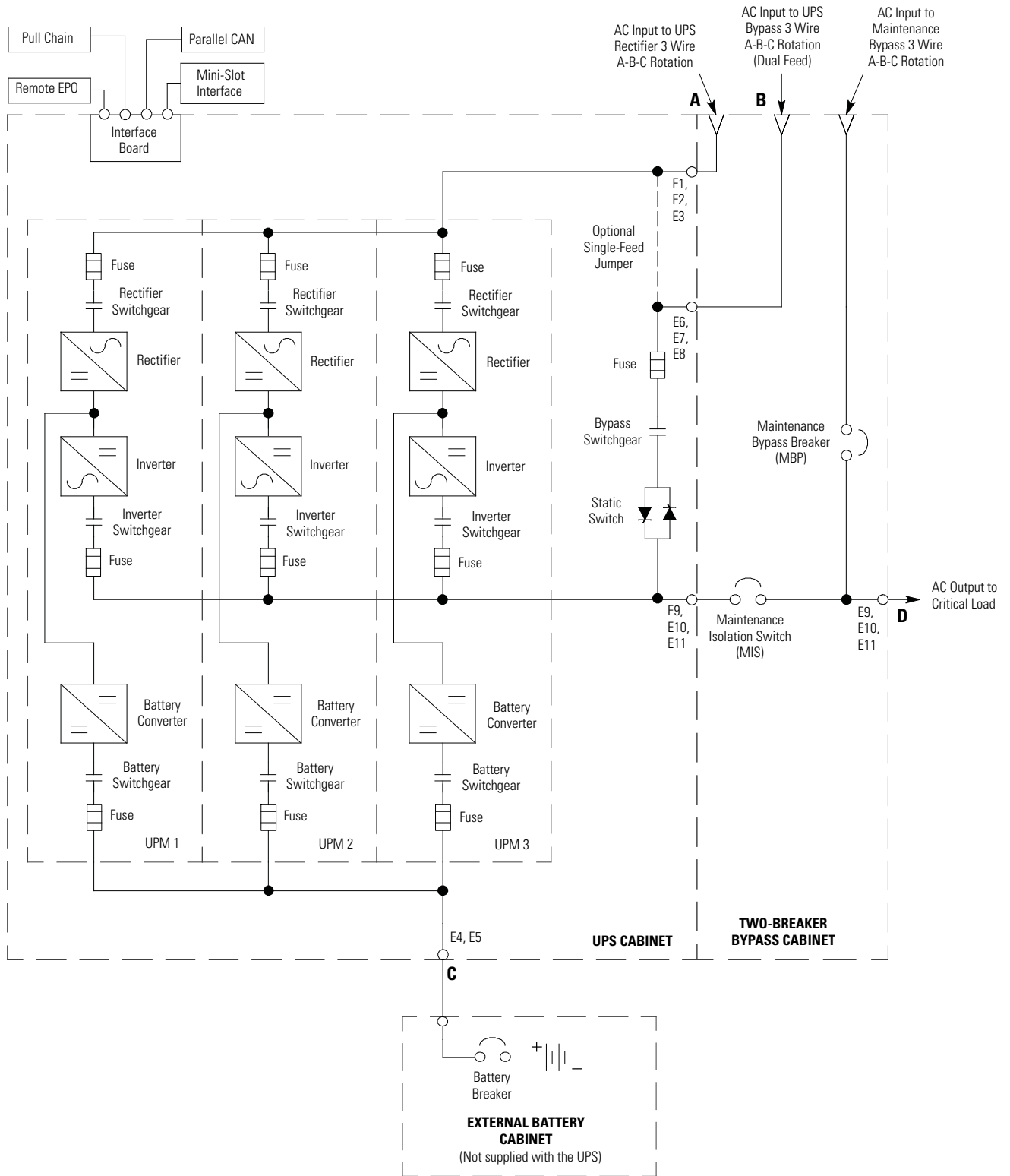
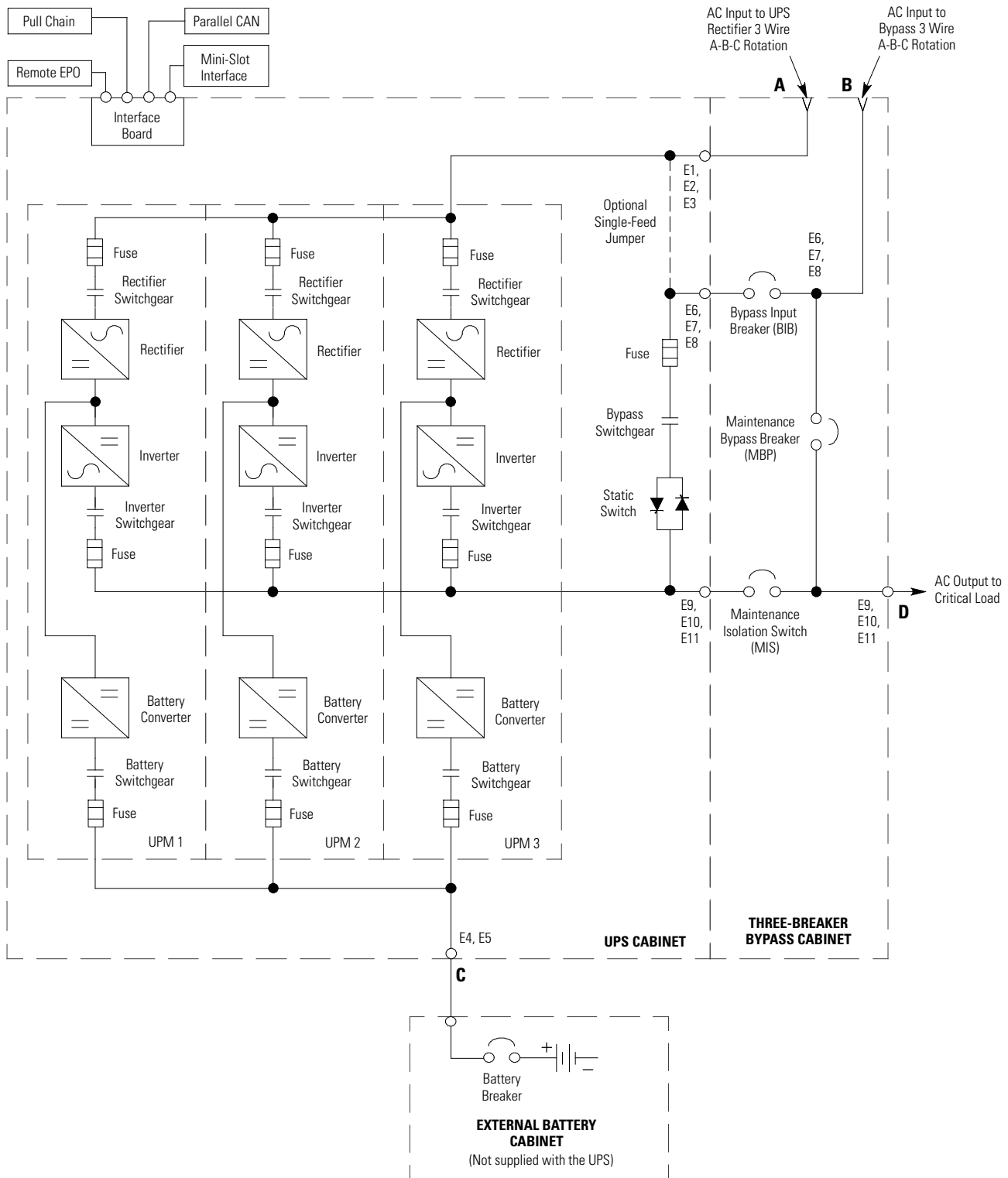

Figure 5-15. Eaton 93PM-100-3 UPS System with Two-Breaker Bypass Online

Understanding UPS Operation



NOTE Callout letters **A, B, C, and D** map to Table 3-5.

Figure 5-16. Eaton 93PM-100-3 UPS System with Three-Breaker Bypass Online

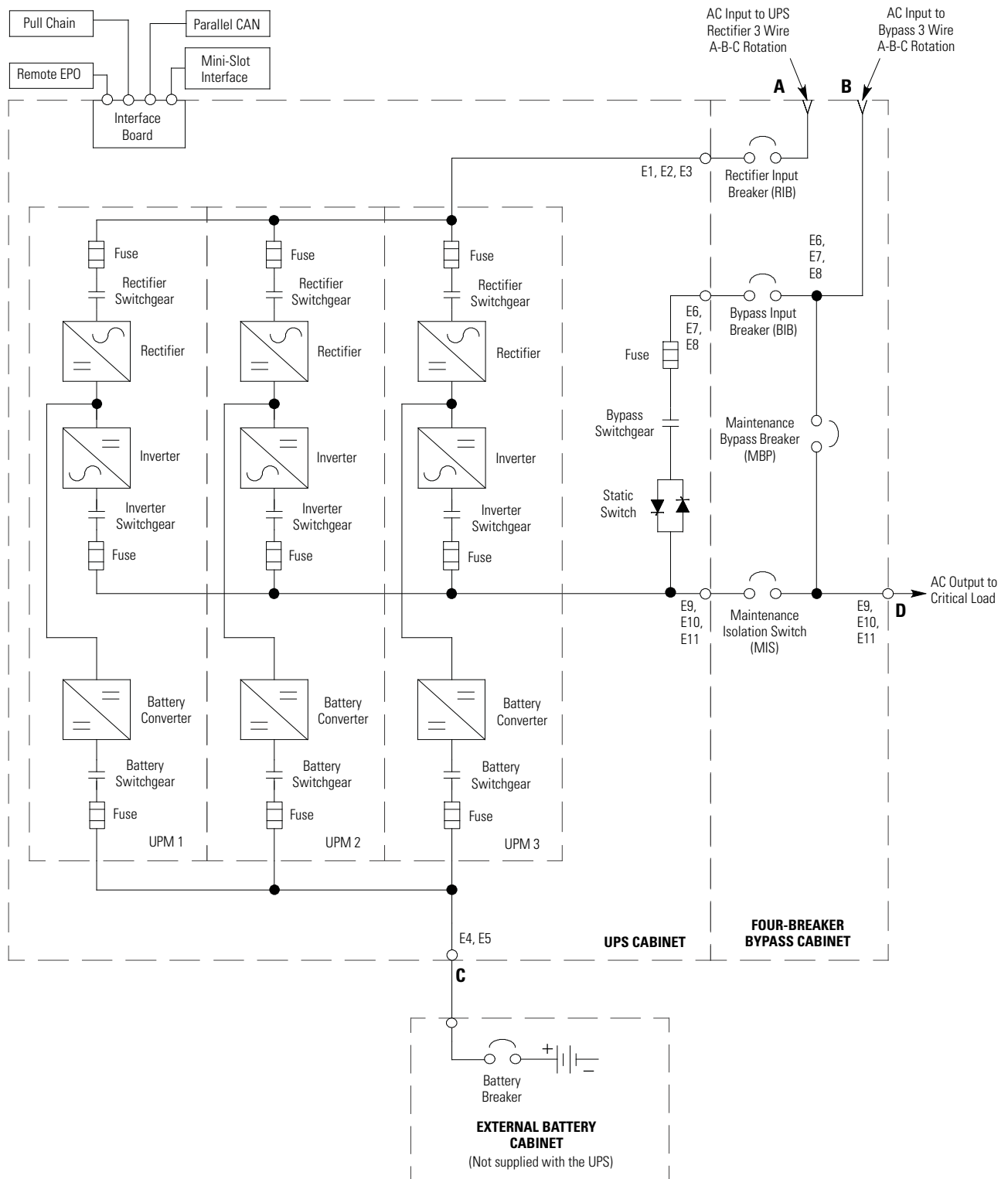

NOTE Callout letters A, B, C, and D map to Table 3-5.

Figure 5-17. Eaton 93PM-100-3 UPS System with Four-Breaker Bypass Online

This page intentionally left blank.

Chapter 6 UPS Operating Instructions

This section describes how to operate the UPS.

NOTE 1 Before starting the UPS, ensure all installation tasks are complete and a preliminary startup has been performed by authorized service personnel. The preliminary startup verifies all electrical interconnections to ensure the installation was successful and the system operates properly.



NOTE 2 Read this section of the manual and have thorough knowledge of UPS operation before attempting to operate any of the controls.

6.1 UPS Controls and Indicators

The controls and indicators identified and described in this section are used to set up, control, and monitor UPS operation. Figure 6-1 shows the control panel location on the front door of the UPS. For a description of the UPS control panel functions, and how to control and monitor UPS operation, see paragraph 6.2.

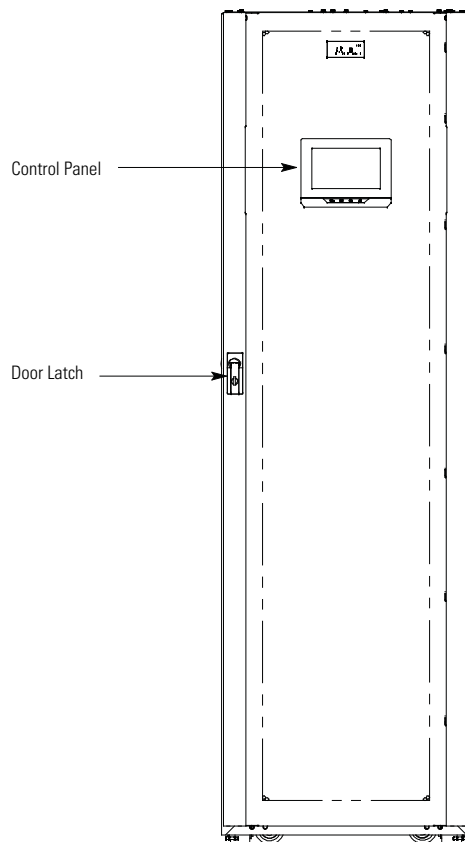

Figure 6-1. UPS Controls and Indicators

6.2 Using the Control Panel

The following paragraphs describe the UPS control panel, including controls and indicators, and how to monitor UPS operation. The control panel is shown in Figure 6-2.

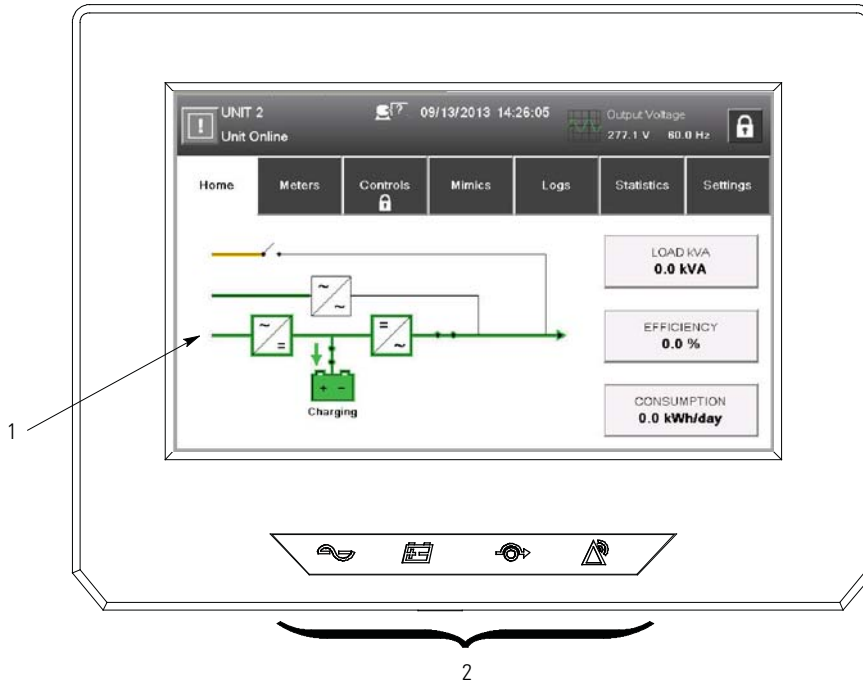

Figure 6-2. UPS Control Panel

The control panel consists of:

- A color liquid crystal touch screen display (**1**)
- A horizontal row of status indicators (**2**). See paragraph 6.2.1.

The following paragraphs describe using the UPS control panel to monitor the UPS. See paragraph 6.3 for use of the operational controls.



When the unit powers up, the screen displays the as shown in Figure 6-2.

6.2.1 Status Indicators

The four symbols on the bottom of the control panel are status indicators. These colored light emitting diode (LED) lamps work with the alarm horn to provide the operating status of the UPS.

Table 6-1 describes the status indicators.

Table 6-1. Status Indicators

Indicator	Status	Description
 Green	On	The UPS is in Double Conversion mode. The power module is supplying power to the critical load.
	Off	The UPS is turned off.
 Yellow	On	The UPS is in Battery mode. Because Battery mode is a normal condition of the UPS, the normal indicator also remains illuminated.
	On	The UPS is in Bypass mode. The critical load is supported by the bypass source. The normal indicator is not illuminated when the system is in Bypass mode.
 Red	On	The UPS has an active alarm and requires immediate attention. The LCD shows the highest priority active alarms. All alarms are accompanied by an audible horn. To silence the horn, touch any control panel button. The Alarm indicator may be illuminated along with other indicators.
	Flashing	There is a new UPS alarm condition. The indicator flashes until acknowledged by touching any control panel button once.

6.2.2 System Events

When the UPS system is running in Double Conversion mode, it continually monitors itself and the incoming utility power. In Battery or Bypass modes, the UPS may issue alarms to let you know exactly what event caused the change from Double Conversion mode. System events on the UPS can be indicated by horns, lights, messages, or all three.

Select the **LOGS** tab from the navigation bar on main menu screen to display the active events screen. This screen shows any currently active alarms, notices, or commands. For more information on using the events screen, see paragraph 6.2.6.

- **System Event Horns** – The system event horn beeps to alert an operator that an event needing attention is taking place. The horn cycles at a half-second rate. To silence the horn, touch any control panel button.
- **System Event Indicators** – The status indicators on the UPS control panel work with the event horn to let the operator know when the UPS is operating in any mode other than double conversion. Only the normal mode indicator is illuminated during normal UPS system operation. The other indicators illuminate to indicate alarms or events. When an alarm occurs, first check these indicators to see what type of event has taken place. For descriptions of the status indicators, see paragraph 6.2.1.
- **System Event Messages** – When a system event occurs, a message appears on the LCD in the UPS status area. This message is also written to the Events Log and may be added to the History Log. The messages are divided into four categories: alarms, notices, status, and commands.

6.2.3 Using the LCD Touch Screen

The LCD touch screen on the control panel provides an operator interface with the UPS system. Figure 6-3 identifies the display areas discussed in the following sections.

All functions and commands are accessed by touching or tapping the screen tabs or buttons. When text input is required, either a Qwerty keyboard or numeric keypad will be displayed.

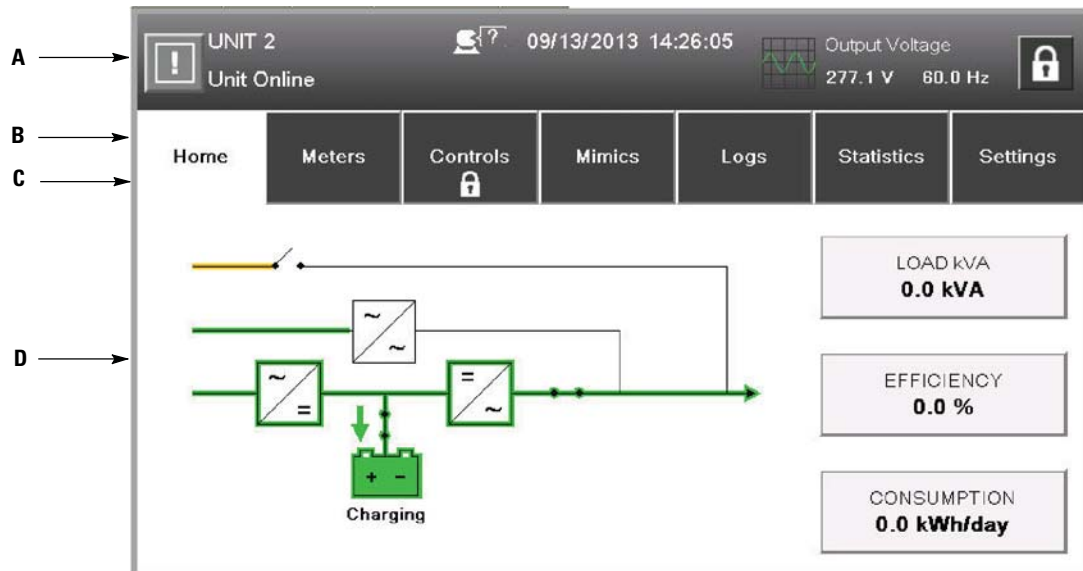

Figure 6-3. Parts of the LCD

- A Status Bar** displays the UPS name, UPS state, current date and time, meter information, active alarms and notices, and a sign in/sign out button. For more information about alarms and notices, see paragraph 6.2.2.
- B Main Menu Navigation Bar** displays main menu functions and selections as tab buttons. To select a screen function touch the tab name.
- C Secondary Menu Navigation Bar** displays functions and selections related to the current screen as tab buttons. To select a screen function touch the tab name.
- D Information Area** contains status data, operational controls, acknowledgments, action confirmations, and screen prompts.

You can use the LCD touch screen to:

- Look at a log of UPS events (alarms, notices, and commands) (see paragraph 6.2.6)
- Monitor UPS operation (see paragraph 6.2.6)
- Set UPS parameters (see paragraph 6.2.6)
- Control UPS operation (see paragraphs 6.2.6 and 6.2.8)

6.2.4 Using the Menu

The UPS navigation tab menu bar allows you to display data in the information area to help you monitor and control UPS operation. Table 6-2 shows the basic menu structure.

Table 6-2. Display Function Menu Map

Menu Option	Description
HOME	Displays the system status both graphically (mimic) and written.
METERS	Displays performance meters for the system or critical load.
CONTROLS	Displays the Controls screen.
MIMIC	Displays the mimic screens and access to system information screens.
LOGS	Displays the list of active events and provides access to historical system events.
STATISTICS	Displays UPS statistical data (uptime, downtime, maintenance, efficiency, etc).
SETTINGS	Allows access to various screen controlled variables for the system operation. Settings include date and time for the time stamp, display language, the unit name, meter subscripts, password, and view the firmware version numbers Used only by service personnel.



NOTE Screens shown are representative examples of system operation. The screen data will vary based on system activity at the time of observation.

6.2.5 Mimic Screen

Figure 6-4 shows the Main Menu and Mimic screen.

The Mimic screen shows the internal components of the UPS cabinet and a real-time graphical representation of the operating status of the system.

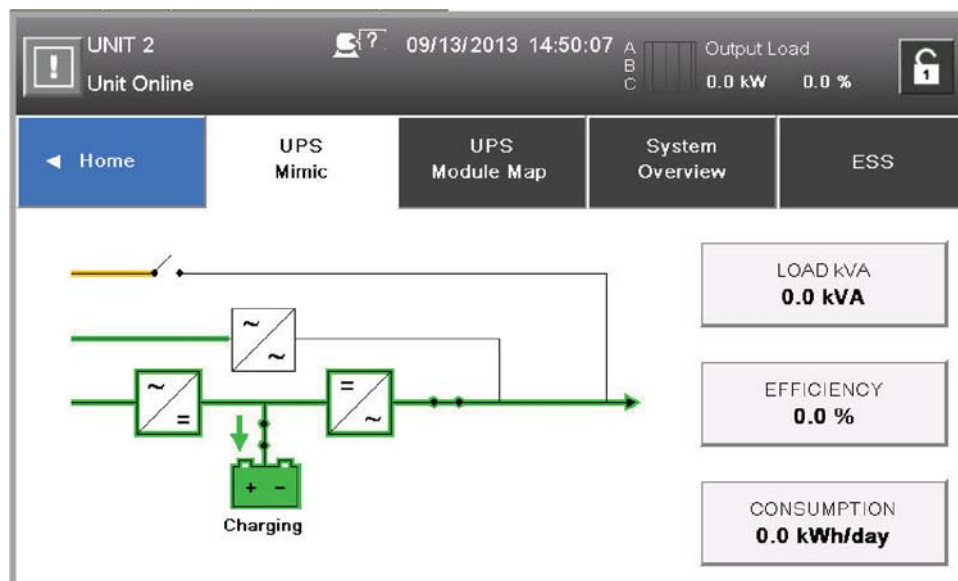

Figure 6-4. Main Menu and Mimic Screen

6.2.6 Display Menu Operation

Table 6-3 describes the menu functions and how to use them.

Table 6-3. Display Menu Operation

Function	Subfunction	Operation
Home		An overview of UPS operation, including information on load, efficiency and consumption.
Meters – UPS		The Meter screens show the UPS meter readings for the unit. The default voltage displayed on these screens is phase-to-neutral. These can be changed to display the voltage phase-to-phase (A-B, B-C, C-A). Tap the METERS tab on the main menu navigation bar to display the METER SUMMARY screen (see Figure 6-5). The current UPS readings are displayed in the information area of the screen. To display individual meter details, tap the desired meter button for to display the detailed meter screen.
	Output – UPS	The Output screen shows output voltage (phase to neutral), output current (each phase), and frequency being supplied by the UPS, as well as the kVA, kW, and power factor measurements.
	Input – UPS	The Input screen shows input voltage (phase to neutral), input current (each phase), and frequency of the incoming utility source, as well as the kVA, kW, and power factor measurements.
	Bypass	The Bypass screen shows the bypass input voltage (phase to neutral), input current (each phase), and frequency of the incoming utility source, as well as the kVA, kW, and power factor measurements.
	Battery – UPS	The Battery screen displays the battery voltage (Vdc) and the battery current (Idc).
Mimics	UPS Mimic	Tap the MIMICS tab on the main menu navigation bar to display an overview of UPS operation, including information on load, efficiency and consumption. If there is an error, an error indicator is displayed next to the affected part. Active events log can be opened by tapping the error indicator.
	UPS Module Map	Tap the UPS MODULE MAP tab on the secondary menu navigation bar to display the status of each UPM.
	System Overview	Tap the SYSTEM OVERVIEW tab on the secondary menu navigation bar to display the status and meters summary for each UPS.
	ESS	Tap the ESS tab on the secondary menu navigation bar to display the approximate consumption and energy savings of ESS mode.
Logs	Active	Tap the LOGS tab on the main menu navigation bar to display the ACTIVE EVENTS screen (see Figure 6-6). A listing of all system events that are currently active is displayed. The most recent event is listed first. As events clear, they are removed from the Events listing. To scroll through the events, press the up or down scroll bar.
	System Log (Historical)	Tap the SYSTEM LOG tab on the secondary menu navigation bar to display the SYSTEM LOG screen (see Figure 6-7). The history Log lists up to 512 events in chronological order, with the most recent event listed last (once 512 is reached, the earliest event is overwritten). The end of the log (the most recent events) is displayed first; scroll upward to view older event listings. To scroll through the events, press the up or down scroll bar.
Settings		Configurable system settings. Tap the SETTINGS tab on the main menu navigation bar to display the settings screen. Settings may be password restricted. Settings Level 2 default password is 0101.
	User	Tap the USER tab on the secondary menu navigation bar to display the USER screen (see Figure 6-8). Tap the INFORMATION or ABOUT button to display system information (see Figure 6-9 and Figure 6-10).
	Configuration	Tap the CONFIGURATION tab on the secondary menu navigation bar to display the screen. Tap the function to be changed. Make and save the changes. Follow screen prompts to accept or abort changes. For additional functions, tap the 2 button. See Figure 6-11 and Figure 6-12 for configuration screens.
Statistics	Statistics Summary	Tap the STATISTICS tab on the main menu navigation bar to display a summary of UPS statistics (see Figure 6-13).
	Statistics Details	Tap the desired statistic button for to display the detailed statistic screen.
Controls		See paragraph 6.2.8 for details.

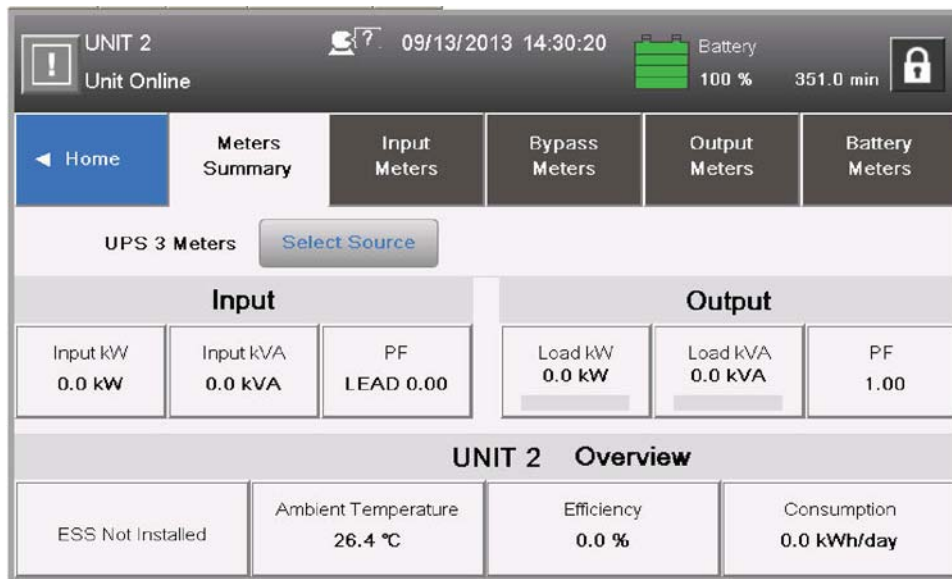

Figure 6-5. Typical Meters Summary Screen

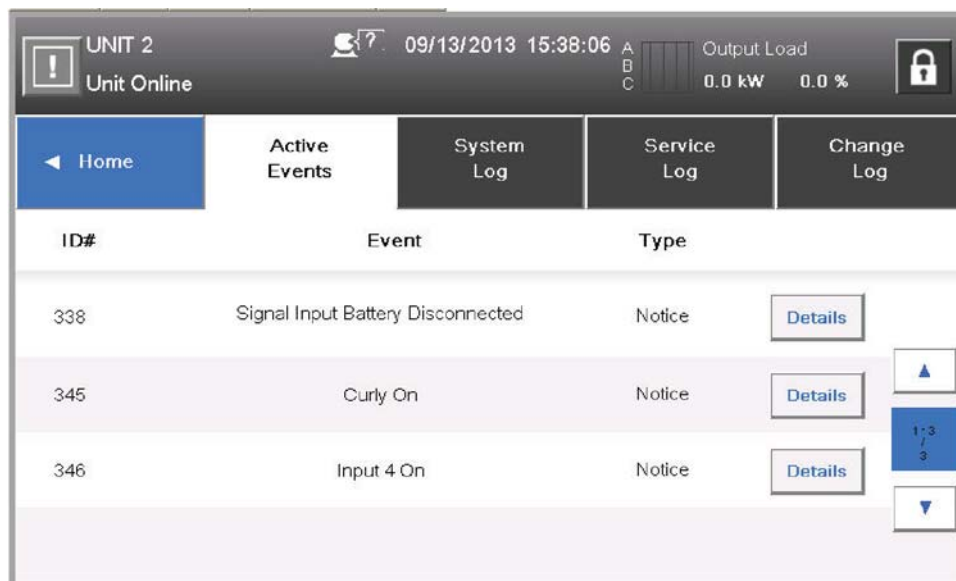

Figure 6-6. Typical Active Events Screen

Date	ID#	Event	Source	Type	
09/13/2013 12:51:43:594	89	ABM State Floating On	UPM1	Status	Details
09/13/2013 12:51:43:534	89	ABM State Floating On	UPM2	Status	Details
09/13/2013 12:51:33:694	88	ABM State Charging On	UPM1	Status	Details
09/13/2013 12:51:30:634	88	ABM State Charging On	UPM2	Status	Details

Figure 6-7. Typical System Log Screen



Figure 6-8. Typical Settings User Screen

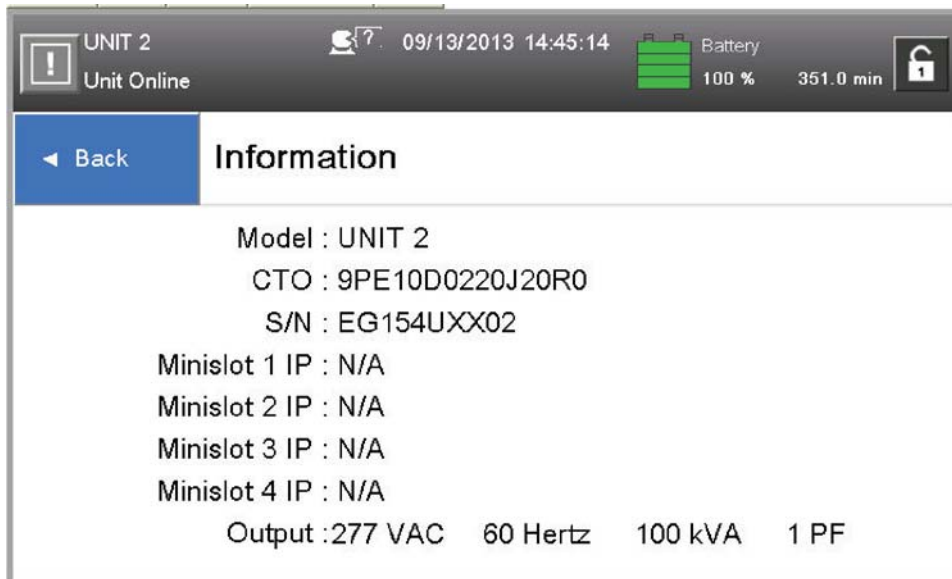

Figure 6-9. Typical Information Screen



Figure 6-10. Typical About Screen

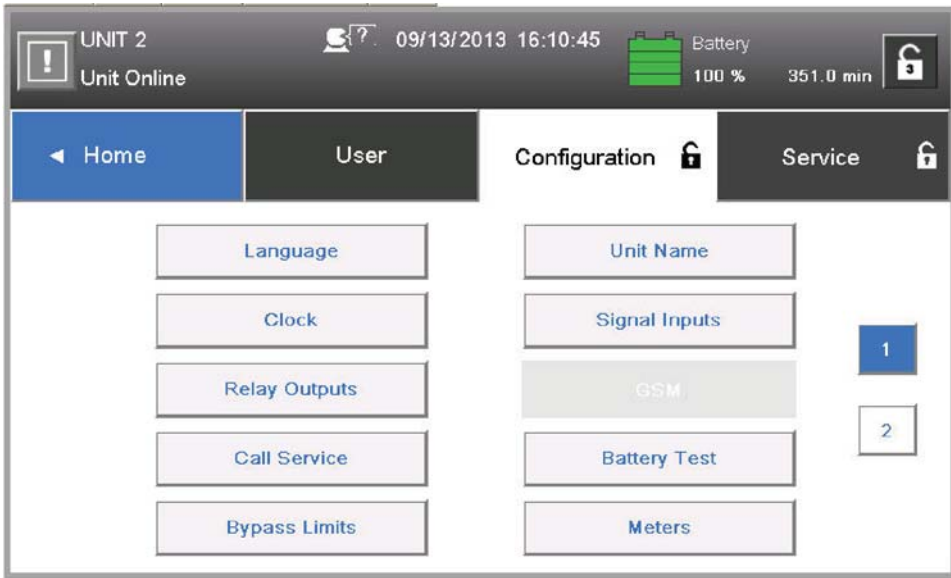

Figure 6-11. Typical Settings Configuration 1 Screen

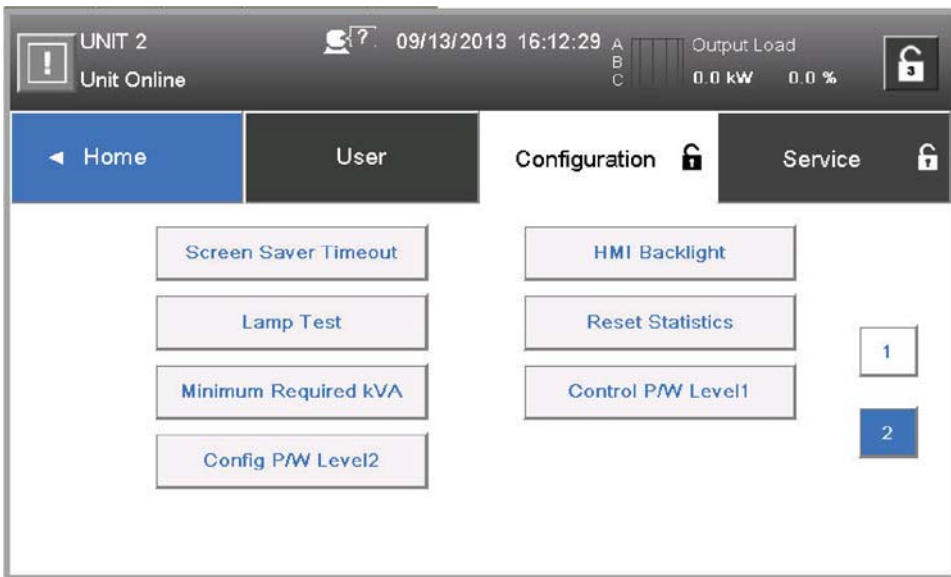

Figure 6-12. Typical Settings Configuration 2 Screen



Figure 6-13. Typical Statistics Screen

6.2.7 Sign In

The Controls and Setting screens are restricted. The user must sign in using a password to gain access.

To Sign in:

1. Tap the lock button in the upper right corner of the screen. The sign in screen is displayed (see Figure 6-14).
2. Tap the password entry area on the screen.
3. Enter the password using the keypad displayed and tap the return key (see Figure 6-15).
Level 1 default password is 1111. Settings Level 2 default password is 0101.
4. Sign in is complete. Tap continue to return to previous screen.

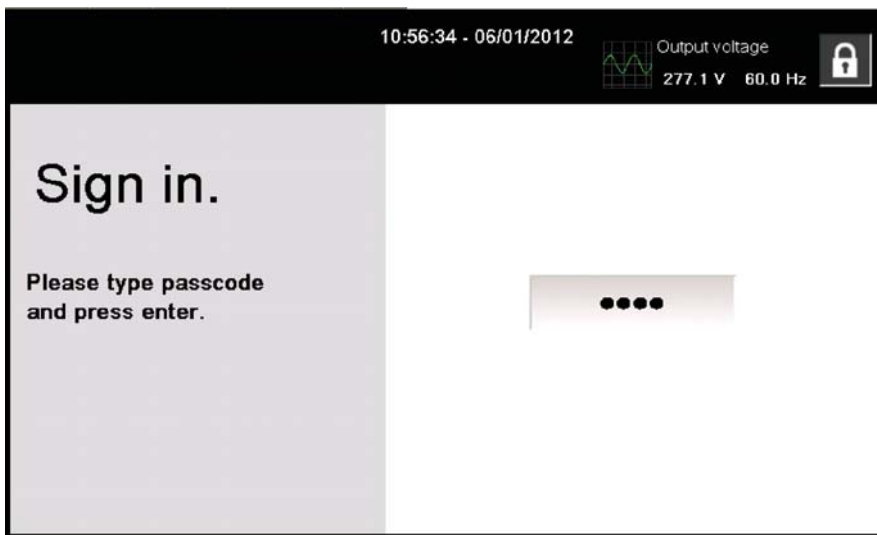

Figure 6-14. Sign In Password Screen

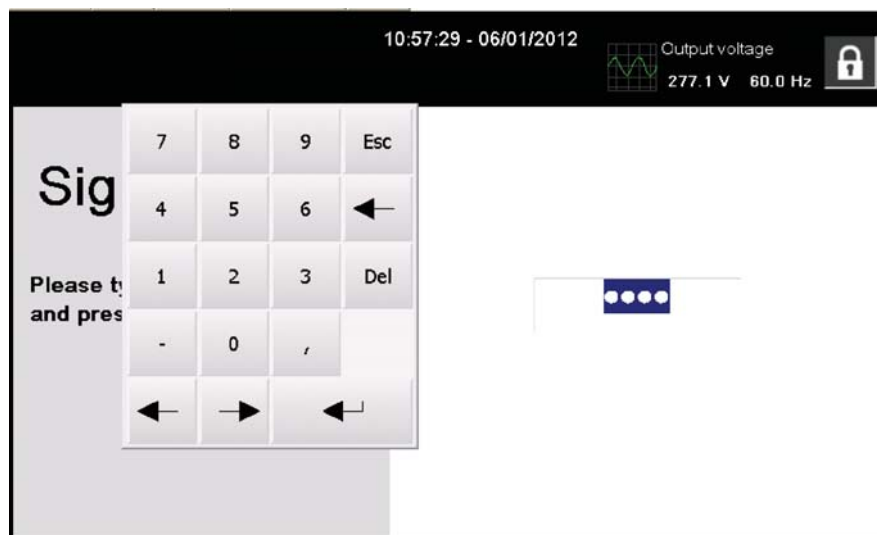

Figure 6-15. Sign In Keypad

6.2.8 System Controls

Tap the **CONTROLS** tab on the main menu navigation bar to display the Controls screen. Double conversion operation, transfer to bypass, shutdown, and charger control commands are controlled through this screen. In addition, the screen displays the current status of the UPS.

Table 6-4 describes the control functions and provides instructions to access and use the command menu screens.

Table 6-5 lists the typical System Status Screen Messages that are displayed during UPS operation.

For UPS operating instructions using the System Controls, see paragraph 6.3 or 6.4.

Figure 6-16 through Figure 6-20 show the major control screens.

Table 6-4. Controls Menu Operation

Function	Subfunction	Operation
System Controls		The CONTROLS tab on the main menu navigation bar displays the System Controls screen.
	System Status	GO ONLINE starts the UPS in Double Conversion mode or transfers the UPS to Double Conversion mode from Bypass mode.
	Bypass	GO TO BYPASS starts the UPS in Bypass mode or transfers the UPS to Bypass mode from Double Conversion mode.
	Charger	TURN ON CHARGER/TURN OFF CHARGER sets the battery charger on or off.
	Battery Test	RUN BATTERY TEST starts the battery test.

Table 6-5. Typical System Status Messages

Function	Message
UPS	Double Conversion; Bypass; ESS
Bypass	Off; On; Available
Charger	Charger Resting; Charger

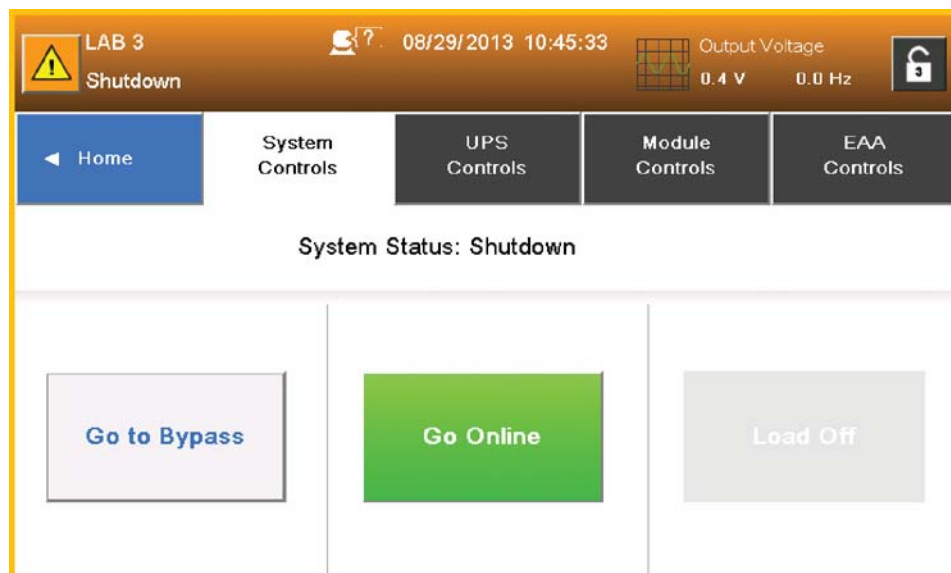

Figure 6-16. Typical System Control Screen

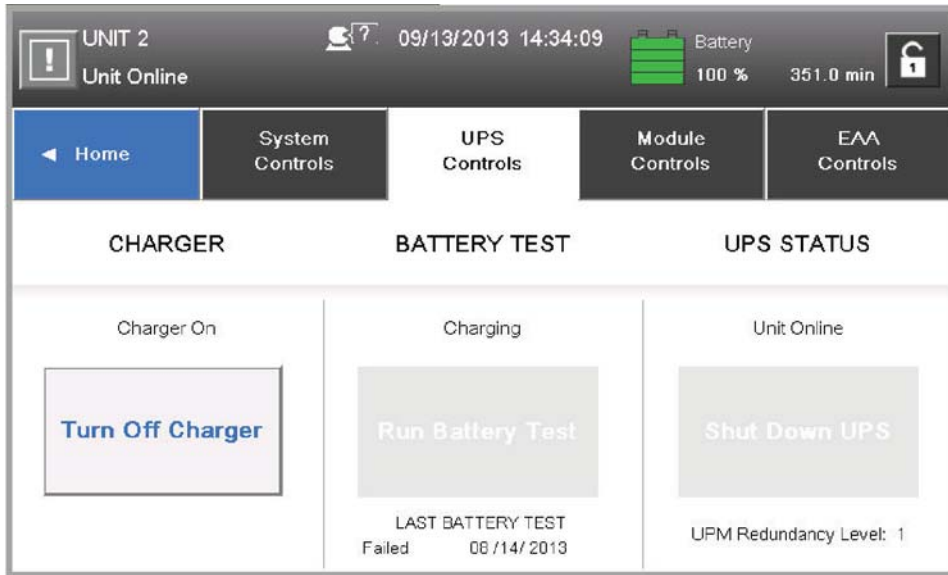

Figure 6-17. Typical UPS Control Screen

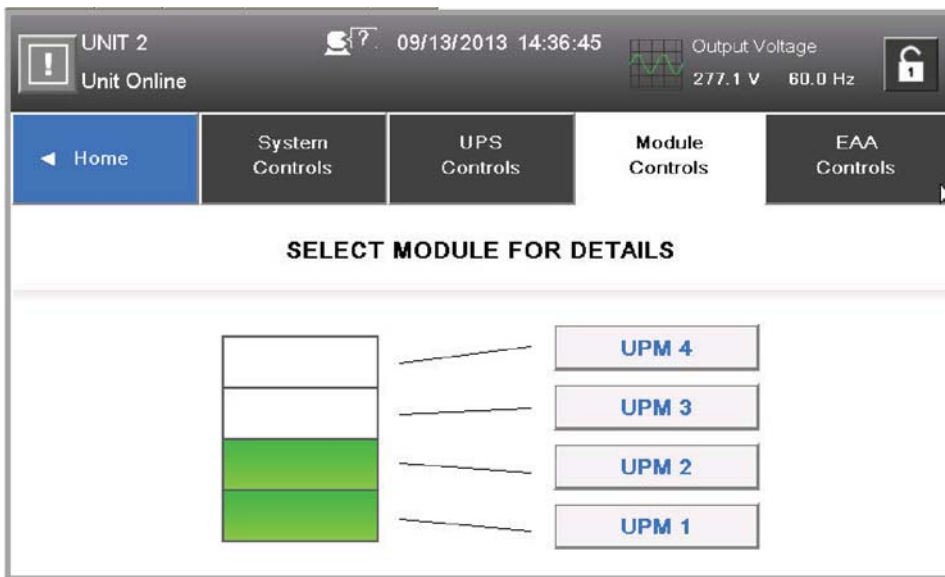

Figure 6-18. Typical UPM Select Screen

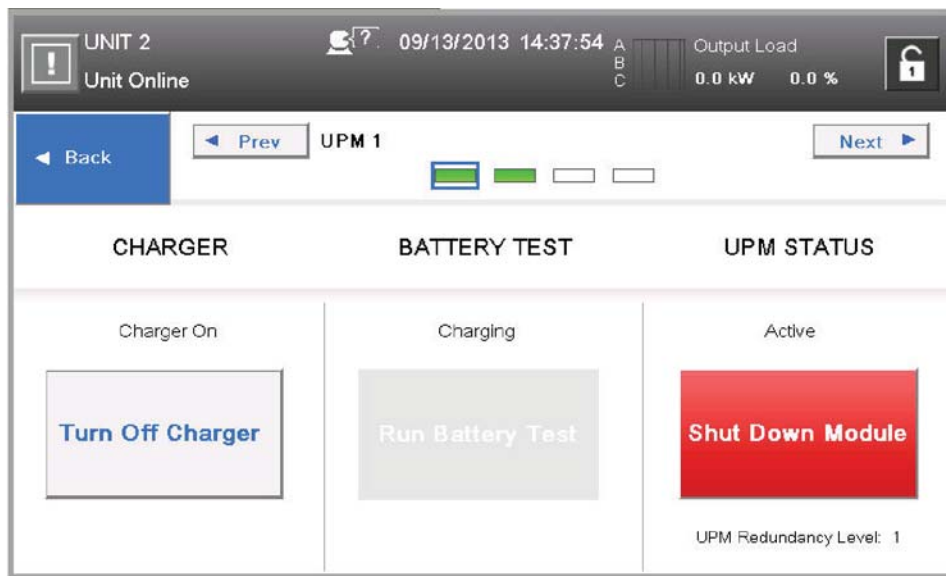

Figure 6-19. Typical UPM Control Screen

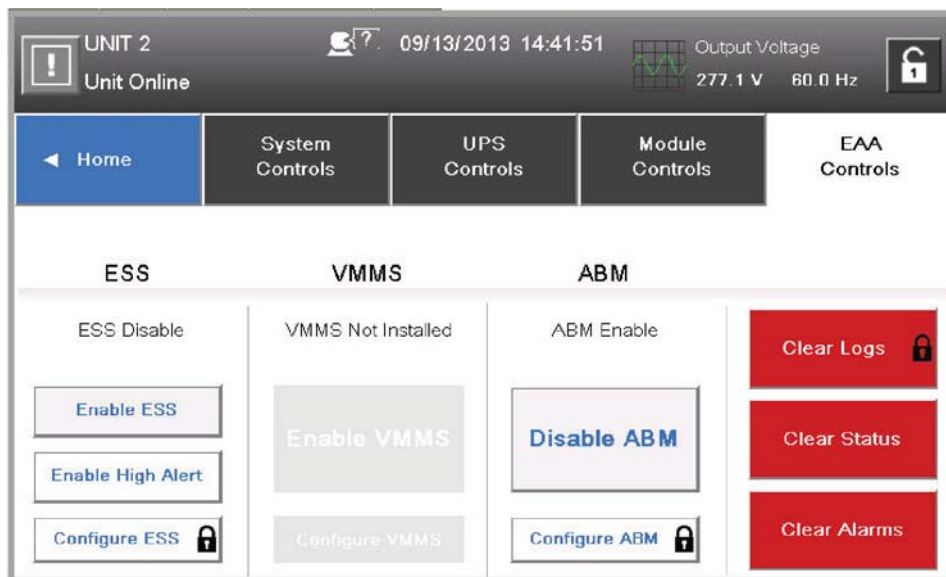

Figure 6-20. Typical EAA Control Screen

6.3 Single UPS Operation

NOTE 1 If an Integrated Battery Cabinet (IBC) is installed, refer to the *Eaton 93PM Integrated Battery Cabinet Installation Manual – Large and Large High Rate* or the *Eaton 93PM Integrated Battery Cabinet Installation Manual-Small* listed in paragraph 1.8 for IBC battery breaker location.



NOTE 2 If an Sidecar Integrated Accessory Cabinet-Bypass (SIAC-B) is installed, refer to the *Eaton 93PM Sidecar Integrated Accessory Cabinet-Bypass Installation and Operation (50 kW and 100 kW SIAC-B) Manual* listed in paragraph 1.8 for operating instructions.

NOTE 3 If an Integrated Accessory Cabinet-Distribution (IAC-D) is installed, refer to the *Eaton 93PM Integrated Accessory Cabinet-Distribution (50 kW, 100 kW, 150 kW, and 200 kW IAC-D) Installation and Operation Manual* listed in paragraph 1.8 for operating instructions.

6.3.1 Starting the UPS in Double Conversion Mode

To start the UPS system:

1. Close the UPS input feeder circuit breaker.
2. If dual feed, close the UPS bypass feeder circuit breaker.
3. If IBCs are installed, close the battery breakers.
4. Observe the UPS control panel display becoming active, indicating logic power.
5. Verify no alarms are active.
6. Tap the **CONTROLS** tab on the main menu navigation bar. The System Control screen is displayed.
7. Tap the **GO ONLINE** button.
8. If requested, enter the Level 1 password. Default password is 1111.

The rectifier and inverter turn on. The inverter continues to ramp up to full voltage.

Once the inverter reaches full voltage, the UPS inverter switchgear closes and the static switch turns off. Power is now supplied to the critical load in dual conversion mode. It takes approximately one minute for the UPS to achieve the dual conversion mode.

The Normal status indicator is illuminated.

6.3.2 Starting the UPS in Bypass Mode

If the inverter output of the UPS is not available and the critical load needs to be energized:

 **CAUTION**

In Bypass mode, the critical load is not protected from commercial power interruptions and abnormalities.

1. Close the UPS input feeder circuit breaker.
2. If dual feed, close the UPS bypass feeder circuit breaker.
3. If IBCs are installed, close the battery breakers.
4. Observe the UPS control panel display becoming active, indicating logic power.
5. Verify no alarms are active.

6. Tap the **CONTROLS** tab on the main menu navigation bar. The System Control screen is displayed.
7. Tap the **GO TO BYPASS** button.
The critical load is immediately supplied by the bypass source, in Bypass mode.
The **BYPASS** status indicator is illuminated.

6.3.3 Starting the UPMs

To start the power modules without transferring the critical load to Double Conversion mode:

1. Close the UPS input feeder circuit breaker.
2. If dual feed, close the UPS Bypass input feeder circuit breaker.
3. Observe the UPS control panel becoming active, indicating logic power.
4. Verify no alarms are active.
5. Tap the **CONTROLS** tab on the main menu navigation bar. The System Control screen is displayed.
6. Tap the **MODULES CONTROLS** tab on the secondary Control menu navigation bar. The UPM Select screen is displayed.
7. On the UPM Select screen, select UPM 1. The UPM Control Screen is displayed.
8. Tap the **START MODULE** button.
The UPM 1 rectifier and inverter turn on. When the inverter reaches full voltage, the UPS is ready to transfer to the Double Conversion mode and supply the critical load.
9. Repeat Steps 5 through 8 selecting UPM 2 to start UPM 2.
The UPM 2 rectifier and inverter turn on. When the inverter reaches full voltage, the UPS is ready to transfer to the Double Conversion mode and supply the critical load.
10. Repeat Steps 5 through 8 selecting UPM 3 to start UPM 3.
The UPM 3 rectifier and inverter turn on. When the inverter reaches full voltage, the UPS is ready to transfer to the Double Conversion mode and supply the critical load.

6.3.4 Starting a Single UPM

To Start a single UPM:

1. Close the UPS input feeder circuit breaker.
2. If dual feed, close the UPS Bypass input feeder circuit breaker.
3. Observe the UPS control panel becoming active, indicating logic power.
4. Verify no alarms are active.
5. Tap the **CONTROLS** tab on the main menu navigation bar. The System Control screen is displayed.
6. Tap the **MODULES CONTROLS** tab on the secondary Control menu navigation bar. The UPM Select screen is displayed.
7. On the UPM Select screen, select the UPM to start. The UPM Control Screen is displayed.
8. Tap the **START MODULE** button.
The UPM rectifier and inverter turn on. When the inverter reaches full voltage, the UPS is ready to transfer to the Double Conversion mode and supply the critical load.

6.3.5 Transfer from Double Conversion to Bypass Mode

To transfer the critical load to Bypass mode:

 **CAUTION**

In Bypass mode, the critical load is not protected from commercial power interruptions and abnormalities.

1. Tap the **CONTROLS** tab on the main menu navigation bar. The System Control screen is displayed.
2. Tap the **GO TO BYPASS** button.

The UPS transfers to Bypass mode, and the critical load is immediately supplied by the bypass source. If the bypass source is not available, the power module remains on and an alarm sounds.

The **BYPASS** status indicator is illuminated. The power module remains on.

 **WARNING**

Power is present inside the UPS cabinet.

6.3.6 Transfer from Bypass to Double Conversion Mode

To transfer the critical load to Normal mode:

1. Tap the **CONTROLS** tab on the main menu navigation bar. The System Control screen is displayed.
2. Tap the **GO ONLINE** button.

The UPS transfers to Double Conversion mode. If the power module is not available, the system remains on bypass and an alarm sounds.

The **NORMAL** status indicator is illuminated.

6.3.7 Transfer from ESS Mode to Double Conversion Mode

To transfer the load to Standard Normal mode:

1. Tap the **CONTROLS** tab on the main menu navigation bar. The Control screen is displayed.
2. Tap the **EAA CONTROLS** tab on the secondary Control menu navigation bar. The **EAA CONTROLS** screen is displayed.
3. Tap the **DISABLE ESS** button.

The UPS transfers to Double Conversion mode.

The **NORMAL** status indicator is illuminated.

6.3.8 Transfer from Double Conversion Mode to ESS Mode

To transfer the load to HE Normal mode:

1. Tap the **CONTROLS** tab on the main menu navigation bar. The Control screen is displayed.
2. Tap the **EAA CONTROLS** tab on the secondary Control menu navigation bar. The **EAA CONTROLS** screen is displayed.
3. Tap the **ENABLE ESS** button.

The UPS transfers to ESS mode if no abnormal power conditions are detected. If abnormal power conditions are detected, the UPS will wait and transfer to ESS mode when conditions are cleared.

The **NORMAL** status indicator is illuminated.

6.3.9 Transfer from Double Conversion to Bypass Mode and Shut Down UPMs

To transfer the critical load to Bypass mode and shut down the UPMs:

1. Transfer the critical load to bypass by performing the procedure in paragraph 6.3.5.
2. Tap the **CONTROLS** tab on the main menu navigation bar. The System Control screen is displayed.
3. Tap the **MODULES CONTROLS** tab on the secondary Control menu navigation bar. The UPM Select screen is displayed.
4. On the UPM Select screen, select UPM 1. The UPM Control Screen is displayed.
5. Tap the **SHUT DOWN MODULE** button.
The UPM status indicates SHUTDOWN. The power module is turned off.
Logic power remains on.
6. Repeat Steps 2 through 5 selecting UPM 2 to shut down UPM 2.
The UPM status indicates SHUTDOWN. The power module is turned off.
Logic power remains on.
7. Repeat Steps 2 through 5 selecting UPM 3 to shut down UPM 3.
The UPM status indicates SHUTDOWN. The power module is turned off.
Logic power remains on.

6.3.10 Single UPM Shutdown

To shut down a single UPM:

1. Tap the **CONTROLS** tab on the main menu navigation bar. The System Control screen is displayed.
2. Tap the **MODULES CONTROLS** tab on the secondary Control menu navigation bar. The UPM Select screen is displayed.
3. On the UPM Select screen, select the UPM to shutdown. The UPM Control Screen is displayed.
4. Tap the **SHUT DOWN MODULE** button.
The UPM status indicates SHUTDOWN. The power module is turned off. The remaining UPMs continue to supply the critical load.
Logic power remains on.

6.3.11 Single UPM Restart

To restart a single UPM from a shutdown state:

1. Tap the **CONTROLS** tab on the main menu navigation bar. The System Control screen is displayed.
2. Tap the **MODULES CONTROLS** tab on the secondary Control menu navigation bar. The UPM Select screen is displayed.
3. On the UPM Select screen, select the UPM to start. The UPM Control Screen is displayed.
4. Tap the **START MODULE** button.

The UPM rectifier and inverter turn on. When the inverter reaches full voltage, the UPS is ready to transfer to the Double Conversion mode and supply the critical load.

6.3.12 UPS and Critical Load Shutdown

To perform maintenance or service on the critical load, shut down power to the load:

1. Turn off all equipment that is being powered by the UPS.
2. Perform the Load Off procedure in paragraph 6.3.15.
The inverter and bypass switchgear open, and the power module is turned off.
3. Perform the battery charger off procedure in paragraph 6.3.13.
The rectifier and battery switchgear open.

WARNING

Power is present inside the UPS cabinet until the upstream input feeder circuit breakers and battery breakers are opened.

4. Open the UPS input feeder circuit breaker.
5. If dual feed, open the UPS bypass feeder circuit breaker.
6. If IBCs are installed, open all battery breakers.

6.3.13 Charger Control

To turn the battery charger on:

1. Tap the **CONTROLS** tab on the main menu navigation bar. The Control screen is displayed.
2. Tap the **UPS CONTROLS** tab on the secondary navigation bar. The UPS Control screen is displayed.
3. Tap the **TURN ON CHARGER** button.

To turn the battery charger off:

1. Tap the **CONTROLS** tab on the main menu navigation bar. The Control screen is displayed.
2. Tap the **UPS CONTROLS** tab on the secondary navigation bar. The UPS Control screen is displayed.
3. Tap the **TURN OFF CHARGER** button.

6.3.14 Battery Test

NOTE 1 The UPS has a user initiated battery test intended to determine if the batteries are able to support the load.

 **NOTE 2** The battery test is only able to be initiated when the battery is fully charged. This normally occurs within 72 hours of the start of a charging cycle. The command will not be shown if the test is not able to be run.

To start the battery test:

1. Tap the **CONTROLS** tab on the main menu navigation bar. The System Control screen is displayed.
2. Tap the **UPS CONTROLS** tab on the secondary navigation bar. The UPS Control screen is displayed.
3. Tap the **RUN BATTERY TEST** button.

6.3.15 Using the UPS LOAD OFF Command

An UPS shutdown is initiated by the **LOAD OFF** command on the UPS Control screen. The UPS **LOAD OFF** controls the UPS output by powering down the UPS and de-energizing the critical load.

The UPS (including Bypass) remains off until restarted.

To use the **LOAD OFF** command:

1. Tap the **CONTROLS** tab on the main menu navigation bar. The System Control screen is displayed.

 **CAUTION**

All power to the critical load is lost when LOAD OFF is selected in the following step. You should use this feature only when you want to de-energize the critical load.

2. Tap the **LOAD OFF** button.

An action confirmation screen is displayed. Follow the on screen prompts to shut down the UPS or to cancel the shutdown. Selecting **YES** will immediately shut down the UPS and de-energize the critical load. Selecting **NO** will abort the shutdown

 **CAUTION**

Do not attempt to restart the system after Load Off until the cause of the shutdown has been identified and cleared.

3. To restart the UPS after using the **LOAD OFF** follow the procedure in paragraph 6.3.1 or 6.3.2.

 **WARNING**

Power is present inside the UPS cabinet until the upstream input feeder circuit breakers and battery breakers are opened.

6.3.16 Using the Remote Emergency Power-off Switch

A UPS emergency power-off is initiated by the REPO pushbutton switch. In an emergency, you can use this switch to control the UPS output. The REPO switch de-energizes the critical load and powers down the UPS immediately, without asking for verification.

The UPS, including Bypass, remains off until restarted.

⚠ CAUTION

All power to the critical load is lost when the REPO switch is activated in the following step. You should use this feature only when you want to de-energize the critical load.

i NOTE The following instructions are for the Eaton-supplied REPO switch. If a customer-supplied REPO switch is used, it may not activate in the same manner; refer to the operating instructions provided with the switch.

To use the REPO switch:

1. Firmly push the red pushbutton until it locks into place. The switch latches into the activated state (see Figure 6-21).

The rectifier, inverter, battery, and bypass switchgear open, and the power module is turned off immediately, without asking for verification.

⚠ CAUTION

Do not attempt to restart the system after the REPO until the cause of the shutdown has been identified and cleared.

2. To deactivate the REPO switch in preparation for restarting the UPS, insert the supplied key and rotate clockwise until the red pushbutton releases (see Figure 6-21). To remove the key, rotate the key back to the vertical position.
3. Restart the UPS by following the procedure in paragraph 6.3.1 or 6.3.2.

⚠ WARNING

Power is present inside the UPS cabinet until the upstream input feeder circuit breakers and battery breakers are opened.

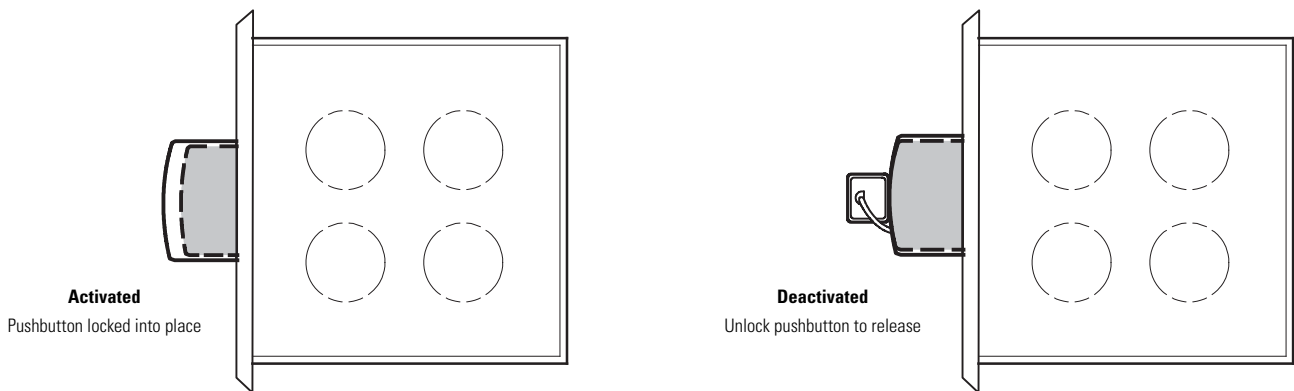

Figure 6-21. REPO Operation

6.4 Multiple External Parallel System Operation

NOTE 1 If an Integrated Battery Cabinet (IBC) is installed, refer to the *Eaton 93PM Integrated Battery Cabinet Installation Manual – Large and Large High Rate* or the *Eaton 93PM Integrated Battery Cabinet Installation Manual-Small* listed in paragraph 1.8 for IBC battery breaker location.

NOTE 2 If an Sidecar Integrated Accessory Cabinet-Bypass (SIAC-B) is installed, refer to the *Eaton 93PM Sidecar Integrated Accessory Cabinet-Bypass Installation and Operation (50 kW and 100 kW SIAC-B) Manual* listed in paragraph 1.8 for operating instructions.



NOTE 3 If an Sidecar Integrated Accessory Cabinet-Tie (SIAC-T) or Sidecar Integrated Accessory Cabinet-Tie Bypass (SIAC-TB) is installed, refer to the *Eaton 93PM Sidecar Integrated Accessory Cabinet-Tie and Tie Bypass (50 kW and 100 kW SIAC-T, and 50 kW and 100 kW SIAC-TB) Installation and Operation Manual* listed in paragraph 1.8 for operating instructions.

NOTE 4 If an Integrated Accessory Cabinet-Tie (IAC-T) is installed, refer to the *Eaton 93PM Integrated Accessory Cabinet-Tie (50 kW and 100 kW IAC-T) Installation and Operation Manual* listed in paragraph 1.8 for operating instructions.

NOTE 5 If an Integrated Accessory Cabinet-Distribution (IAC-D) is installed, refer to the *Eaton 93PM Integrated Accessory Cabinet-Distribution (50 kW, 100 kW, 150 kW, and 200 kW IAC-D) Installation and Operation Manual* listed in paragraph 1.8 for operating instructions.

6.4.1 Starting the Parallel System in Double Conversion Mode

To start the UPS system:

1. Close all Module Output Breakers (MOBs).
2. Close the UPS input feeder circuit breaker.
3. If dual feed, close the UPS bypass feeder circuit breaker.
4. If IBCs are installed, close the battery breakers.
5. Observe the UPS control panel display becoming active, indicating logic power.
6. Verify no alarms are active.
7. Tap the **CONTROLS** tab on the main menu navigation bar. The System Control screen is displayed.
8. Tap the **GO ONLINE** button.
9. If requested, enter the Level 1 password. Default password is 1111.

The rectifier and inverter turn on. The inverter continues to ramp up to full voltage.

Once the inverter reaches full voltage, all UPS inverter switchgear close and the static switches turn off. Power is now supplied to the critical load in dual conversion mode from all UPSs. It takes approximately one minute for the UPSs to achieve the dual conversion mode.

The Normal status indicator is illuminated.

6.4.2 Starting the Parallel System in Bypass Mode

If the inverter output of the UPS is not available and the critical load needs to be energized:

 **CAUTION**

In Bypass mode, the critical load is not protected from commercial power interruptions and abnormalities.

1. Close all Module Output Breakers (MOBs).
2. Close the UPS input feeder circuit breaker.
3. If dual feed, close the UPS bypass feeder circuit breaker.
4. If IBCs are installed, close the battery breakers.
5. Observe the UPS control panel display becoming active, indicating logic power.
6. Verify no alarms are active.
7. Tap the **CONTROLS** tab on the main menu navigation bar. The System Control screen is displayed.
8. Tap the **GO TO BYPASS** button.

The critical load is immediately supplied by the bypass source, in Bypass mode from all UPSs.

The **BYPASS** status indicator is illuminated.

6.4.3 Starting the Parallel System UPMs

To start the power modules without transferring the critical load to Double Conversion mode:

1. Close the UPS input feeder circuit breaker.
2. If dual feed, close the UPS Bypass input feeder circuit breaker.
3. Observe the UPS control panel becoming active, indicating logic power.
4. Verify no alarms are active.
5. Tap the **CONTROLS** tab on the main menu navigation bar. The System Control screen is displayed.
6. Tap the **MODULES CONTROLS** tab on the secondary Control menu navigation bar. The UPM Select screen is displayed.
7. On the UPM Select screen, select UPM 1. The UPM Control Screen is displayed.
8. Tap the **START MODULE** button.

The UPM 1 rectifier and inverter turn on. When the inverter reaches full voltage, the UPS is ready to transfer to the Double Conversion mode and supply the critical load.

9. Repeat Steps 5 through 8 selecting UPM 2 to start UPM 2.

The UPM 2 rectifier and inverter turn on. When the inverter reaches full voltage, the UPS is ready to transfer to the Double Conversion mode and supply the critical load.

10. Repeat Steps 5 through 8 selecting UPM 3 to start UPM 3.

The UPM 3 rectifier and inverter turn on. When the inverter reaches full voltage, the UPS is ready to transfer to the Double Conversion mode and supply the critical load.

11. Repeat Steps 1 through 10 for each UPS in the parallel system.

6.4.4 Starting a Single UPM

To Start a single UPM:

1. Close the UPS input feeder circuit breaker.
2. If dual feed, close the UPS Bypass input feeder circuit breaker.
3. Observe the UPS control panel becoming active, indicating logic power.
4. Verify no alarms are active.
5. Tap the **CONTROLS** tab on the main menu navigation bar. The System Control screen is displayed.
6. Tap the **MODULES CONTROLS** tab on the secondary Control menu navigation bar. The UPM Select screen is displayed.
7. On the UPM Select screen, select the UPM to start. The UPM Control Screen is displayed.
8. Tap the **START MODULE** button.

The UPM rectifier and inverter turn on. When the inverter reaches full voltage, the UPS is ready to transfer to the Double Conversion mode and supply the critical load.

6.4.5 Transfer from Double Conversion to Bypass Mode

To transfer the critical load to Bypass mode:

 **CAUTION**

In Bypass mode, the critical load is not protected from commercial power interruptions and abnormalities.

1. Tap the **CONTROLS** tab on the main menu navigation bar. The System Control screen is displayed.
2. Tap the **GO TO BYPASS** button.

All of the UPSs transfer to Bypass mode, and the critical load is immediately supplied by the bypass source. If the bypass source is not available, the power module remains on and an alarm sounds.

The **BYPASS** status indicator is illuminated. The power module remains on.

 **WARNING**

Power is present inside the UPS cabinet.

6.4.6 Transfer from Bypass to Double Conversion Mode

To transfer the critical load to Normal mode:

1. Tap the **CONTROLS** tab on the main menu navigation bar. The System Control screen is displayed.
2. Tap the **GO ONLINE** button.

All of the UPSs transfer to Double Conversion mode. If the power module is not available, the system remains on bypass and an alarm sounds.

The **NORMAL** status indicator is illuminated.

6.4.7 Transfer from ESS Mode to Double Conversion Mode

To transfer the load to Standard Normal mode:

1. Tap the **CONTROLS** tab on the main menu navigation bar. The Control screen is displayed.
2. Tap the **EAA CONTROLS** tab on the secondary Control menu navigation bar. The **EAA CONTROLS** screen is displayed.
3. Tap the **DISABLE ESS** button.

All of the UPSs transfer to Double Conversion mode.

The **NORMAL** status indicator is illuminated.

6.4.8 Transfer from Double Conversion Mode to ESS Mode

To transfer the load to HE Normal mode:

1. Tap the **CONTROLS** tab on the main menu navigation bar. The Control screen is displayed.
2. Tap the **EAA CONTROLS** tab on the secondary Control menu navigation bar. The **EAA CONTROLS** screen is displayed..
3. Tap the **ENABLE ESS** button.

All of the UPSs transfer to ESS mode if no abnormal power conditions are detected. If abnormal power conditions are detected, the UPSs will wait and transfer to ESS mode when conditions are cleared.

The **NORMAL** status indicator is illuminated.

6.4.9 Transfer from Double Conversion to Bypass Mode and Shut Down all UPMs

To transfer the critical load to Bypass mode and shut down the UPMs:

1. Transfer the critical load to bypass by performing the procedure in paragraph 6.4.5.
2. Tap the **CONTROLS** tab on the main menu navigation bar. The System Control screen is displayed.
3. Tap the **MODULES CONTROLS** tab on the secondary Control menu navigation bar. The UPM Select screen is displayed.
4. On the UPM Select screen, select UPM 1. The UPM Control Screen is displayed.
5. Tap the **SHUT DOWN MODULE** button.

The UPM status indicates SHUTDOWN. The power module is turned off.

Logic power remains on.

6. Repeat Steps 2 through 5 selecting UPM 2 to shut down UPM 2.

The UPM status indicates SHUTDOWN. The power module is turned off.

Logic power remains on.

7. Repeat Steps 2 through 5 selecting UPM 3 to shut down UPM 3.

The UPM status indicates SHUTDOWN. The power module is turned off.

Logic power remains on.

8. Repeat Steps 2 through 7 for each UPS in the parallel system.

6.4.10 Single UPM Shutdown

To shut down a single UPM:

1. Tap the **CONTROLS** tab on the main menu navigation bar. The System Control screen is displayed.
2. Tap the **MODULES CONTROLS** tab on the secondary Control menu navigation bar. The UPM Select screen is displayed.
3. On the UPM Select screen, select the UPM to shutdown. The UPM Control Screen is displayed.
4. Tap the **SHUT DOWN MODULE** button.
The UPM status indicates SHUTDOWN. The power module is turned off. The remaining UPMs continue to supply the critical load.
Logic power remains on.

6.4.11 Single UPM Restart

To restart a single UPM from a shutdown state:

1. Tap the **CONTROLS** tab on the main menu navigation bar. The System Control screen is displayed.
2. Tap the **MODULES CONTROLS** tab on the secondary Control menu navigation bar. The UPM Select screen is displayed.
3. On the UPM Select screen, select the UPM to start. The UPM Control Screen is displayed.
4. Tap the **START MODULE** button.
The UPM rectifier and inverter turn on. When the inverter reaches full voltage, the UPS is ready to transfer to the Double Conversion mode and supply the critical load.

6.4.12 Single UPS Shutdown

To Shutdown a single UPS:



NOTE To shut down a single UPS, MOBs with dual auxiliary contacts must be installed and connected according to the procedure in paragraph 4.11.6.

To shut down a single UPS:

1. Open the MOB for the UPS being shut down.
2. On the UPS being shut down, tap the **CONTROLS** tab on the main menu navigation bar. The System Control screen is displayed.
3. Tap the **GO TO BYPASS** button.
The UPS being shut down transfers to Bypass mode. The **BYPASS** status indicator is illuminated. The power module remains on.
4. Tap the **CONTROLS** tab on the main menu navigation bar. The System Control screen is displayed.
5. Tap the **MODULES CONTROLS** tab on the secondary Control menu navigation bar. The UPM Select screen is displayed.
6. On the UPM Select screen, select UPM 1. The UPM Control Screen is displayed.
7. Tap the **SHUT DOWN MODULE** button.
The UPM status indicates SHUTDOWN. The input, output, and battery switchgear open, and the power module is turned off.
Logic power remains on.
8. Repeat Steps 4 through 7 selecting UPM 2 to shut down UPM 2.

The UPM status indicates SHUTDOWN. The input, output, and battery switchgear open, and the power module is turned off.

Logic power remains on.

9. Repeat Steps 4 through 7 selecting UPM 3 to shut down UPM 3.

The UPM status indicates SHUTDOWN. The input, output, and battery switchgear open, and the power module is turned off.

Logic power remains on.

 **WARNING**

Power is present inside the UPS cabinet until the upstream input feeder circuit breakers and battery breakers are opened.

10. Open the all of the UPSs input feeder circuit breaker.
11. If dual feed, open all of the UPSs bypass feeder circuit breaker.
12. If IBCs are installed, open all battery breakers.

The UPS is now completely shut down.

6.4.13 Single UPS Restart

To restart a single UPS from a shutdown state:

1. Close the MOB for the UPS being restarted.
2. Close the UPS input feeder circuit breaker for the UPS being restarted.
3. If dual feed, close the UPS bypass feeder circuit breaker for the UPS being restarted.
4. If IBCs are installed, close the battery breakers for the UPS being restarted.
5. On the UPS being restarted, observe the UPS control panel display becoming active, indicating logic power.
6. Verify no alarms are active.
7. On the UPS being restarted, tap the **CONTROLS** tab on the main menu navigation bar. The System Control screen is displayed.
8. Tap the **GO ONLINE** button.
9. If requested, enter the Level 1 password. Default password is 1111.

The rectifier and inverter turn on. The inverter continues to ramp up to full voltage.

Once the inverter reaches full voltage, all UPS inverter switchgear close and the static switches turn off. Power is now supplied to the critical load in dual conversion mode from all UPSs. It takes approximately one minute for the UPSs to achieve the dual conversion mode.

The Normal status indicator is illuminated.



NOTE

If the UPS is starting on a bus with other online paralleled UPSs, the UPS will not go to bypass during startup. The UPS will start, sync to the other UPSs online, and go online.

6.4.14 Parallel System and Critical Load Shutdown

To perform maintenance or service on the critical load, shut down power to the load:

1. Turn off all equipment that is being powered by the UPS parallel system.
2. Transfer the UPSs to bypass by performing the procedure in paragraph 6.4.9.
3. Perform the Load Off procedure in paragraph 6.4.17.

The inverter and bypass switchgear open, and the power module is turned off on all UPSs.

4. Perform the battery charger off procedure in paragraph 6.4.15.

The rectifier and battery switchgear open.

WARNING

Power is present inside the UPS cabinet until the upstream input feeder circuit breakers and battery breakers are opened.

5. Open the all of the UPSs input feeder circuit breaker.
6. If dual feed, open all of the UPSs bypass feeder circuit breaker.
7. If IBCs are installed, open all battery breakers.

6.4.15 Charger Control

To turn the battery charger on:

1. Tap the **CONTROLS** tab on the main menu navigation bar. The Control screen is displayed.
2. Tap the **UPS CONTROLS** tab on the secondary navigation bar. The UPS Control screen is displayed.
3. Tap the **TURN ON CHARGER** button.

To turn the battery charger off:

1. Tap the **CONTROLS** tab on the main menu navigation bar. The Control screen is displayed.
2. Tap the **UPS CONTROLS** tab on the secondary navigation bar. The UPS Control screen is displayed.
3. Tap the **TURN OFF CHARGER** button.

6.4.16 Battery Test

NOTE 1 This UPS has a user initiated battery test intended to determine if the batteries are able to support the load.

 **NOTE 2** The battery test is only able to be initiated when the battery is fully charged. This normally occurs within 72 hours of the start of a charging cycle. The command will not be shown if the test is not able to be run.

To start the battery test:

1. Tap the **CONTROLS** tab on the main menu navigation bar. The System Control screen is displayed.
2. Tap the **UPS CONTROLS** tab on the secondary navigation bar. The UPS Control screen is displayed.
3. Tap the **RUN BATTERY TEST** button.

6.4.17 Using the LOAD OFF Command

An UPS shutdown is initiated by the **LOAD OFF** command on the UPS Control screen. The UPS **LOAD OFF** controls the UPSs output by powering down all of the UPSs and de-energizing the critical load.

The UPSs (including Bypass) remains off until restarted.

To use the **LOAD OFF** command:

1. Tap the **CONTROLS** tab on the main menu navigation bar. The System Control screen is displayed.

 **CAUTION**

All power to the critical load is lost when LOAD OFF is selected in the following step. You should use this feature only when you want to de-energize the critical load.

2. Tap the **LOAD OFF** button.

An action confirmation screen is displayed. Follow the on screen prompts to shut down the UPS or to cancel the shutdown. Selecting **YES** will immediately shut down the UPS and de-energize the critical load. Selecting **NO** will abort the shutdown

 **CAUTION**

Do not attempt to restart the system after Load Off until the cause of the shutdown has been identified and cleared.

3. To restart the UPS after using the **LOAD OFF** follow the procedure in paragraph 6.4.1 or 6.4.2.

 **WARNING**

Power is present inside the UPS cabinet until the upstream input feeder circuit breakers and battery breakers are opened.

6.4.18 Using the Remote Emergency Power-off Switch

A UPS emergency power-off is initiated by the REPO pushbutton switch. In an emergency, you can use this switch to control the UPS output. The REPO switch de-energizes the critical load and powers down the UPSs immediately, without asking for verification.

The UPSs, including Bypass, remains off until restarted.

CAUTION

All power to the critical load is lost when the REPO switch is activated in the following step. You should use this feature only when you want to de-energize the critical load.



NOTE

The following instructions are for the Eaton-supplied REPO switch. If a customer-supplied REPO switch is used, it may not activate in the same manner; refer to the operating instructions provided with the switch.

To use the REPO switch:

1. Firmly push the red pushbutton until it locks into place. The switch latches into the activated state (see Figure 6-21).

The rectifier, inverter, battery, and bypass switchgear open, and the power module is turned off immediately on all UPSs, without asking for verification.

CAUTION

Do not attempt to restart the system after the REPO until the cause of the shutdown has been identified and cleared.

2. To deactivate the REPO switch in preparation for restarting the UPS, insert the supplied key and rotate clockwise until the red pushbutton releases (see Figure 6-21). To remove the key, rotate the key back to the vertical position.
 3. Restart the UPS by following the procedure in paragraph 6.4.1 or 6.4.2.
-

WARNING

Power is present inside the UPS cabinet until the upstream input feeder circuit breakers and battery breakers are opened.

This page intentionally left blank.

Chapter 7 Communication

This chapter describes the communication features of the Eaton 93PM UPS. For terminal wiring information, see paragraph 3.2.4 and paragraph 4.11. For location of the customer interface panel and terminals, see Figure 4-9 and Figure 4-10.

7.1 Minislot Cards

The Eaton 93PM UPS has two standard, factory-installed Minislot communication bays. See Figure 4-9 for bay locations. The UPS is compatible with the following Minislot cards (see Figure 7-1):

NOTE Only one Power Xpert® Gateway Minislot UPS Card can be used at one time.

- The Power Xpert® Gateway Minislot (PXGMS) UPS Card provides Web-enabled, real-time monitoring of Eaton 93PM uninterruptible power systems (UPSs) through standard Web pages, Power Xpert software, Intelligent Power Manager (IPM), Intelligent Power Protector (IPP), or third-party software. As an integral part of the Eaton Power Xpert Architecture®, the PXGMS UPS Card provides a central point to connect UPSs to the Ethernet network.

Network managers can view critical downstream device information, such as status, power, energy, and power quality data with an easy-to-use interface.

- Industrial Relay Card-Minislot (IRC-MS) – can be used to indicate the operating status of the UPS system using the customer's monitoring equipment. The Industrial Relay Card uses five isolated normally-open or normally-closed dry relay contacts to indicate the UPS status. Normal, Bypass, Battery, and Alarm modes can be monitored. See Table 7-1 for default triggers. The contact ratings and wire range are listed in the IRC-MS installation guide. One input can be activated by a switch or dry contact. The voltage source is provided by the card, no external voltage source is needed.

For installation and setup of a Minislot card, contact an Eaton service representative (see paragraph 1.8). Refer to the manual supplied with the Minislot card for user instructions.

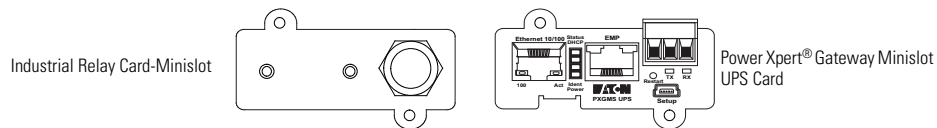

Figure 7-1. Optional Minislot Cards

Table 7-1. IRC-MS Default Triggers

Relay	Trigger
K1	UPS supporting the load
K2	UPS on Battery
K3	Summary alarm
K4	UPS on bypass
K5	UPS battery low

7.2 Building Alarm Monitoring

This standard feature lets you connect the UPS to your building alarms, such as smoke detectors or overtemperature alarms. The building alarm customer interface terminals for external are located inside the UPS. Use twisted-pair wires for each alarm input and common.

The building alarms can be programmed to display the alarm functional name.

7.3 General Purpose Relay Contact

One general purpose relay contact is provided as a standard feature on the UPS. The relay contact customer interface terminals are located inside the UPS. Use twisted-pair wires for the normally-closed or normally-open and common connections.

Normally-closed or normally-open contacts can be used. If the state of the contact changes from the state specified as normal, a signal is issued. This contact can be connected to equipment at the facility (such as a light or an alarm bell) to notify the operator when an alarm is active on the UPS. This feature is useful if the UPS is located in a remote area where the UPS horn may not be heard immediately.

 **CAUTION**

Contacts should not be operated in excess of 30 Vac @ 5A maximum.

 **NOTE** If contact ratings are required that can be operated above the rated voltage and current available with the UPS general purpose relay contacts, an IRC-MS card should be used.

7.4 Predict Pulse Remote Monitoring and Management Service

The Eaton 93PM UPS supports Eaton's PredictPulse remote monitoring and management service. PredictPulse is a subscription monitoring and management service that collects and analyzes data from connected power infrastructure devices, providing us with the insight needed to make recommendations and take action on your behalf. It's also powered by CA Technologies, bringing together the best in hardware and software. PredictPulse Service is included at no charge during the first year of Eaton 93PM UPS operation (warranty period) along with the required connectivity parts. Beyond that, it may be purchased with Eaton Support Agreements or as a standalone subscription after the initial warranty expires. PredictPulse may also be subscribed to for free as part of a 90-day trial period. PredictPulse availability and first year bundled offers may vary by market. For more information, visit www.eaton.com/predictpulse.

7.4.1 PredictPulse Service Features

PredictPulse provides proactive monitoring, an online dashboard, mobile app with alarm status information and a monthly report detailing the ongoing health of your Eaton 93PM UPS. Features include:

- Proactive monitoring that automatically analyzes the status of the Eaton 93PM UPS 96 times every day (every 15 minutes). All health data gathered from the unit, current and historical, is analyzed at the Customer Reliability Center (CRC). Algorithms and sophisticated analytics software is constantly scanning your UPS's data for potential failures. Anomalies are escalated to a Software and Monitoring analyst or Technical Support specialist. Critical events are remotely diagnosed to expedite repairs, including smart dispatch of field technicians with probable cause and likely parts (avoiding return visits due to lack of required parts). Through this service, the CRC can take pre-emptive, corrective action to ensure the highest level of availability of your Eaton 93PM UPS.
- Easy self-installation in minutes from a wizard installer or directly from the PXGMS card. PredictPulse uses standard Eaton connectivity hardware, requiring no special software (devices only need to be connected to a network).

- Ability to give an unlimited number of coworkers access to the real-time data and reports found in PredictPulse's online dashboard and mobile app. This allows you to collaborate and Eaton to notify the most appropriate person responsible for a specific site or device.
- Real-time access to key performance information, alarms and trended health data about your Eaton 93PM UPS via the PredictPulse online dashboard. Depending on the model, the dashboard aggregates all subscribed devices and provides detailed information about voltages, loads, energy savings, service levels, external factors such as temperature and humidity, attached batteries, and system availability. All of these factors contribute to the Relative Performance Index (RPI) score that allows you to compare your unit's health relative to Eaton's optimum UPS operating levels.
- Real-time alarm events for all subscribed devices via the PredictPulse mobile app (Apple and Android). You can track all alarms by device. As critical alarms occur, Eaton will acknowledge them so you know when Eaton has diagnosed the alarm (and pending notification of resolution).
- A monthly summary report that delivers key performance information, alarms and trended health data about your Eaton 93PM UPS, based on the prior month's data.
- A foundation based on CA Technologies' leading Data Center Infrastructure Management (DCIM) software application. This enables powerful reporting, analytics, security, and compatibility with hundreds of power infrastructure devices.

7.4.2 Installing PredictPulse

A quick start guide and self-installation wizard tool are available at www.eaton.com/predictpulse. The latest updates, installation tips and information on connecting PredictPulse are also available at that link. For installation support or questions about PredictPulse, contact predictpulsesupport@eaton.com.

PredictPulse relies on a PXGMS card installed with the UPS to send one-way outbound SMTP e-mails to Eaton, as well as an Environmental Monitoring Probe (EMP) for battery temperature/humidity monitoring. PredictPulse is secure as Eaton never communicates through your firewall—it only listens for health data and alarm data—and uses industry-standard security protocols. By using a common e-mail transport mechanism, you do not have to open your network to proprietary or potentially unsecure protocols and transports. The PXGMS Connectivity Card gathers information directly from the UPS and any external sensors that are attached, and transmits that data every 15 minutes (or 96 times per day), enabling real-time monitoring and advanced virtual preventive maintenance.

This page intentionally left blank.

Chapter 8 UPS Maintenance

The components inside the UPS cabinet are secured to a sturdy metal frame. All repairable parts and assemblies are located for easy removal, with very little disassembly. This design allows authorized service personnel to perform routine maintenance and servicing quickly.

You must schedule periodic performance checks of your UPS system to keep it running properly. Regular routine checks of operation and system parameters enable your system to function efficiently for many trouble-free years.

8.1 Important Safety Instructions

Remember that your UPS system is designed to supply power **EVEN WHEN DISCONNECTED FROM THE UTILITY POWER**. The UPS module interiors are unsafe until the DC power source is disconnected and the electrolytic capacitors are discharged. After disconnecting the utility power and the DC power, authorized service personnel should wait at least five minutes for capacitor bleedoff before attempting internal access to the UPS module.

 **WARNING**

- Servicing and maintenance should be performed by qualified service personnel only.
 - **LETHAL VOLTAGE PRESENT.** This unit should not be operated with the cabinet doors open or protective panels removed. Do not make any assumptions about the electrical state of any cabinet in the UPS system.
-

Each battery string is an energy source in itself. **DO NOT ATTEMPT TO ACCESS ANY INTERNAL AREA OF THE BATTERY STRING YOURSELF. VOLTAGES ARE ALWAYS PRESENT IN THE BATTERY STRING.** If you suspect that a battery string needs service, contact an Eaton service representative.

If the string requires service contact an Eaton service representative.

Observe these precautions when working on or around batteries:

- Remove watches, rings, or other metal objects.
- Use tools with insulated handles.
- Wear rubber gloves and boots.
- Do not lay tools or metal parts on top of batteries.
- Disconnect the charging source prior to connecting or disconnecting terminals.
- Determine if the battery is inadvertently grounded. If it is, remove the source of the ground. Contact with any part of a grounded battery can result in electrical shock. The likelihood of such shock is reduced if such grounds are removed during installation and maintenance.
- When replacing batteries, use the same number of sealed, lead-acid batteries.
- Proper disposal of batteries is required. Refer to your local codes for disposal requirements.
- Do not dispose of batteries in a fire. Batteries may explode when exposed to flame.
- Do not open or mutilate batteries. Released electrolyte is harmful to the skin and eyes. It may be toxic.

8.2 Performing Preventive Maintenance

The UPS system requires very little preventive maintenance. However, the system should be inspected periodically to verify that the units are operating normally and that the batteries are in good condition.

8.2.1 DAILY Maintenance

Perform the following steps daily:

1. Check the area surrounding the UPS system. Ensure the area is not cluttered, allowing free access to the unit.
2. Ensure the air intakes (vents on the front door of the UPS cabinet and the exhaust openings (on the rear of the UPS cabinet) are not blocked.
3. Ensure the operating environment is within the parameters specified in paragraph 3.2.1 and Chapter 9, "Product Specifications."
4. Ensure the UPS is in Normal mode (Normal status indicator is illuminated). If an alarm lamp is illuminated or the Normal status indicator is not illuminated, contact an Eaton service representative.

8.2.2 MONTHLY Maintenance

Perform the following steps monthly:

1. Monitor system parameters as described in paragraph 6.2, "Using the Control Panel"
2. Check the UPS air filter (located behind the front door) and wash or replace as necessary. See Figure 8-1 for filter location. Contact an Eaton service representative for replacement filters.



CAUTION

Verify washed filter is thoroughly dry before reinstalling.

To remove the filters:

- a. Unfasten the front door by lifting the latch from the bottom and turning to the right (counterclockwise) and swing the door open (see Figure 6-1).
 - b. Remove the foam filters from the frame on the front door.
 - c. Replace the washed or new foam filters into the frame on the front door.
 - d. Close the front door and secure the latch.
3. Record maintenance results and any corrective actions in a suitable log.

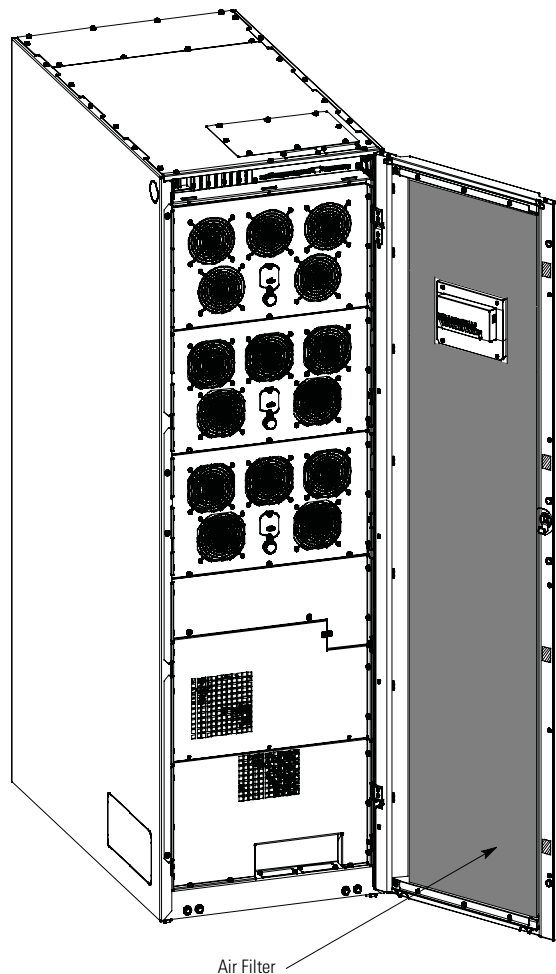

Figure 8-1. Air Filter Location

PERIODIC Maintenance

Periodic inspections of the UPS should be made to determine if components, wiring, and connections exhibit evidence of overheating. Particular attention should be given to the compression lug connections. Maintenance procedures should specify that the compression lug connections be retorqued to values listed in this manual.

8.2.3 ANNUAL Maintenance

Annual preventive maintenance should be performed only by authorized service personnel familiar with maintenance and servicing of the UPS system. Contact an Eaton service representative for more information about service offerings.

8.2.4 BATTERY Maintenance

Contact an Eaton service representative for battery maintenance. Battery replacement and maintenance should be performed only by authorized service personnel.

8.3 Installing Batteries

 **NOTE** There is no manual DC disconnect device within the UPS.

Install batteries in accordance with the battery and battery system manufacturer's instructions.

8.4 Recycling the Used Battery or UPS

Contact your local recycling or hazardous waste center for information on proper disposal of the used battery or UPS.

 **WARNING**

- Do not dispose of the battery or batteries in a fire. Batteries may explode. Proper disposal of batteries is required. Refer to your local codes for disposal requirements.
 - Do not open or mutilate the battery or batteries. Released electrolyte is harmful to the skin and eyes. It may be toxic.
 - A battery can cause electrical shock, burn from high short-circuit current, or fire. Observe proper precautions.
-

 **ATTENTION!**

- Une batterie peut présenter un risque de choc électrique, de brûlure, ou d'incendie. Suivre les précautions qui s'imposent.
 - Pour le remplacement, utiliser le même nombre et modèle des batteries.
 - L'élimination des batteries est réglementée. Consulter les codes locaux à cet effet.
-

 **CAUTION**

Do not discard the UPS or the UPS batteries in the trash. This product contains sealed, lead-acid batteries and must be disposed of properly. For more information, contact your local recycling/reuse or hazardous waste center.

 **CAUTION**

Do not discard waste electrical or electronic equipment (WEEE) in the trash. For proper disposal, contact your local recycling/reuse or hazardous waste center.

8.5 Maintenance Training

A basic training course, available from Eaton Corporation, gives you a competent working knowledge of the UPS system operation and teaches you how to perform first level corrective maintenance. For more information about training and other services, contact the Customer Reliability Center (see paragraph 1.8).

Chapter 9 Product Specifications

9.1 Model Numbers

The UPS is housed in a free-standing cabinet with safety shields behind the door. The UPS is available in 50 or 60 Hz with various output power ratings.

Model	Power Rating	Frequency
Eaton 93PM-100-1 Eaton 93PM-100-2 (N+1)	20 kW	50/60 Hz
Eaton 93PM-100-1 Eaton 93PM-100-2 (N+1)	30 kW	50/60 Hz
Eaton 93PM-100-1 Eaton 93PM-100-2 (N+1)	40 kW	50/60 Hz
Eaton 93PM-100-1 Eaton 93PM-100-2 (N+1)	50 kW	50/60 Hz
Eaton 93PM-100-2 Eaton 93PM-100-3 (N+1)	60 kW	50/60 Hz
Eaton 93PM-100-2 Eaton 93PM-100-3 (N+1)	70 kW	50/60 Hz
Eaton 93PM-100-2 Eaton 93PM-100-3 (N+1)	80 kW	50/60 Hz
Eaton 93PM-100-2 Eaton 93PM-100-3 (N+1)	90 kW	50/60 Hz
Eaton 93PM-100-2 Eaton 93PM-100-3 (N+1)	100 kW	50/60 Hz

9.2 Specifications

The following sections detail the input, output, environmental, and battery specifications for the UPS.

9.2.1 UPS Input

Operating Input Voltage	480 Vac Wye, 3W + ground. Neutral not used.
Operating Input Frequency Range	50/60 Hz
Operating Input Current	See Table 3-4 or Table 3-5. Reduced for Generator Adjustable
Input Current Harmonic Content	3% THD at full load
Power Factor	Minimum 0.99
Line Surges	6 kV OC, 3 kA SC per ANSI 62.41 and IEC 801 4
Battery Voltage	216 cell – 432 Vdc 240 cell – 480 Vdc
Battery Charging Capacity	16.5 A maximum per 50 kW module at full load at nominal input voltage

9.2.2 UPS Output

UPS Output Capacity	100% rated current
Output Voltage Regulation	± 1% (10% to 100% load)
Output Voltage	480 Vac Wye, 3W + ground. No Neutral.
Output Voltage Harmonic Content	1% maximum THD (linear load) 5% maximum THD (nonlinear load)
Output Current	See Table 3-4 or Table 3-5
Output Voltage Balance	< 2% for 100% maximum load imbalance (linear load)
Output Voltage Phase Displacement	< 2.5° for 100% maximum load imbalance (linear load)
Frequency Regulation	0.1 Hz free running
Synchronous to Bypass	± 4 Hz (default setting)
Frequency Slew Rate	1 Hz per second (default setting)
Load Compatibility	0.8 pF Leading 0.8 pF Lagging
Overload Capability	<110% for 10 minutes <125% for 60 seconds <150% for 10 seconds >150% for 300 milliseconds

9.2.3 UPS Environmental

Operating Temperature	5 to 40°C (41 to 104°F) without derating. The recommended operating temperature is 25°C (77°F).
Operating Altitude	Maximum 1500m (5000 ft) at 40°C without derating
Storage Temperature	–25 to +55°C, excluding batteries (prolonged storage above 40°C causes rapid battery self-discharge)
Relative Humidity (operating and storage)	95%, noncondensing
Acoustical Noise	100 kW at 100% load – 65 dBA at a 1m distance, per ISO 7779
Agency Markings	Safety: UL1778 4th Ed./CSA22.2 No. 107.3 2nd Ed.
EMI Emissions and Immunity	Meets IEC 62040-2 C3 and FCC Part 15 Subpart B, ICES-003, CISPR 22, VCCI: Class A, and CISPR 24.
Electrostatic Discharge (ESD) Immunity	Meets IEC 61000-4-2 Level 3 specifications. Withstands up to 4 kV contact pulse without damage and with no disturbance or adverse effect to the critical load.

Warranty

LIMITED FACTORY WARRANTY FOR THREE-PHASE EATON® 93PM UPS AND 93PM UPS ACCESSORY PRODUCTS

WARRANTOR: The warrantor for the limited warranties set forth herein is Eaton Corporation, an Ohio Corporation ("Eaton").

LIMITED WARRANTY: This limited warranty (this "Warranty") applies only to the original end-user (the "End-User") of the Eaton Three-Phase 93PM UPS and 93PM UPS Accessory Products (the "Product") and cannot be transferred. This restriction applies even in the event that the Product is initially sold by Eaton for resale to an End-User. This Warranty gives you specific legal rights, and you may also have other rights which vary from State to State (or jurisdiction to jurisdiction).

WHAT THIS LIMITED WARRANTY COVERS: The warrantor warrants, with the terms of this Warranty, that the Eaton three-phase UPS electronics, Eaton-built accessories, and Eaton -built battery cabinets (individually and collectively, the "Warranted Items") are free from defects in material and workmanship.

For Product installed (and currently located) in the fifty (50) United States and the District of Columbia, if, in the opinion of Eaton, a Warranted Item is defective, Eaton's sole obligation, at the option of Eaton, will be to refurbish or replace such defective Warranted Item (including the costs of providing diagnosis, service, and labor ["labor coverage"]). The defective Warranted Item will be refurbished or replaced onsite at the End-User's location or such other location as determined by Eaton. Any parts that are replaced may be new or reconditioned. All parts replaced by Eaton shall become the property of Eaton.

For Product installed (and currently located) outside the fifty (50) United States and the District of Columbia, if, in the opinion of Eaton, a Warranted Item is defective, Eaton's sole obligation, at the option of Eaton, will be to refurbish or replace such defective Warranted Item (not including the costs of labor coverage). The defective Warranted Item will be refurbished or replaced onsite at the End-User's location or such other location as determined by Eaton. Any parts that are replaced may be new or reconditioned. All parts replaced by Eaton shall become the property of Eaton.

LIMITED WARRANTY PERIOD: The period covered by this Warranty for Product installed (and currently located) in the fifty (50) United States and the District of Columbia is six (6) months from the date of Product purchase for labor coverage when no startup is performed by an authorized Eaton Customer Service Engineer or Agent or twelve (12) months from the date of Product purchase with startup performed by an authorized Eaton Customer Service Engineer or Agent and twelve (12) months from the date of Product purchase or eighteen (18) months from date of Product shipment, whichever occurs first, for the refurbishment/ replacement of parts.

The period covered by this Warranty for Product installed (and currently located) outside the fifty (50) United States and the District of Columbia is twelve (12) months from the date of Product purchase or eighteen (18) months from the date of Product shipment, whichever occurs first, for the refurbishment/replacement of parts.

WHAT THIS LIMITED WARRANTY DOES NOT COVER: This Warranty does not cover any defects or damages caused by: (a) failure to properly store the Product before installation, including the "trickle charge" of batteries no later than the date indicated on the packaging; (b) shipping and delivery of the Product if shipping is FOB Factory; (c) neglect, accident, fire, flood, lightning, vandalism, acts of God, Customer's neglect, abuse, misuse, misapplication, incorrect installation; (d) repair or alteration not authorized in writing by Eaton personnel or performed by an authorized Eaton Customer Service Engineer or Agent; or (e) improper testing, operation, maintenance, adjustment, or any modification of any kind not authorized in writing by Eaton personnel or performed by an authorized Eaton Customer Service Engineer or Agent.

This Warranty is not valid: if the Product's serial numbers have been removed or are illegible. Any Warranted Items repaired or replaced pursuant to this Warranty will be warranted for the remaining portion of the original Warranty subject to all the terms thereof. Eaton does not provide a labor warranty for Product located outside of the fifty (50) United States or the District of Columbia. **Any equipment, parts, or materials included in the Product and not manufactured by Eaton are warranted solely by the manufacturer of such equipment, parts, or materials and are not included as part of this Warranty. Batteries are not warranted by Eaton.**

THIS WARRANTY IS THE END-USER'S SOLE REMEDY AND IS EXPRESSLY IN LIEU OF, AND THERE ARE NO OTHER, EXPRESSED OR IMPLIED GUARANTEES OR WARRANTIES (INCLUDING ANY IMPLIED WARRANTY OF MERCHANTABILITY OR FITNESS FOR ANY PURPOSE, WHICH ARE EXPRESSLY DISCLAIMED). SOME STATES OR JURISDICTIONS DO NOT ALLOW THE EXCLUSION OF EXPRESS OR IMPLIED WARRANTIES, SO THE ABOVE EXCLUSION MAY NOT APPLY TO YOU. IN THAT EVENT, SUCH WARRANTIES ARE LIMITED IN DURATION TO THE LIMITED WARRANTY PERIOD. SOME STATES OR JURISDICTIONS DO NOT ALLOW LIMITATIONS ON HOW LONG AN IMPLIED WARRANTY LASTS OR THE EXCLUSION OR LIMITATION OF INCIDENTAL OR CONSEQUENTIAL DAMAGES, SO THE ABOVE LIMITATIONS AND/OR EXCLUSIONS MAY NOT APPLY TO YOU.

LIMITATION OF LIABILITY: In no event shall Eaton be liable for any indirect, incidental, special or consequential damages of any kind or type whatsoever, resulting from or in connection with any claim or cause of action, whether brought in contract or in tort (including negligence and strict liability). Some States or jurisdictions do not allow the exclusion of limitation of incidental or consequential damages, so the above limitation or exclusion may not apply to you. Eaton shall not be responsible for failure to provide service or parts due to causes beyond Eaton's reasonable control. In no case will Eaton's liability under this Warranty exceed the replacement value of the Warranted Items.

END-USER'S OBLIGATIONS: In order to receive the benefits of this Warranty, the End-User must register the product warranty (via mail or online at www.powerquality.eaton.com/Product-Registration "product registration"); use the Product in a normal way; follow the Product's user's guide; and protect against further damage to the Product if there is a covered defect.

OTHER LIMITATIONS: Eaton's obligations under this Warranty are expressly conditioned upon receipt by Eaton of all payments due to it (including interest charges, if any). During such time as Eaton has not received payment of any amount due to it for the Product, in accordance with the contract terms under which the Product is sold, Eaton shall have no obligation under this Warranty. Also during such time, the period of this Warranty shall continue to run and the expiration of this Warranty shall not be extended upon payment of any overdue or unpaid amounts.

COSTS NOT RELATED TO WARRANTY: The End-User shall be invoiced for, and shall pay for, all services not expressly provided for by the terms of this Warranty, including without limitation site calls involving an inspection that determines no corrective maintenance is required. Any costs for replacement equipment, installation, materials, freight charges, travel expenses, or labor of Eaton representatives outside the terms of this Warranty will be borne by the End-User.

OBTAINING WARRANTY SERVICE: In the USA, call the Eaton Customer Reliability Center 7x24 at 800-843-9433. Outside of the USA, call your local Eaton sales or service representative, or call the Eaton Customer Reliability Center in the United States at 919-845-3633. For comments or questions about this Limited Factory Warranty, write to the Customer Quality Representative, 8609 Six Forks Road, Raleigh, North Carolina 27615 USA.



P-164000227 5